

Air Conditioning  
Technical Data

FHA-A



- > FHA35AVEB
- > FHA50AVEB
- > FHA60AVEB
- > FHA71AVEB
- > FHA100AVEB
- > FHA125AVEB

- > FHA140AVEB



# TABLE OF CONTENTS

## FHA-A

1	Features .....	2
2	Specifications .....	3
	Technical Specifications .....	3
	Electrical Specifications .....	4
3	Safety device settings.....	5
4	Options.....	6
5	Dimensional drawings .....	7
6	Centre of gravity .....	10
7	Piping diagrams .....	12
8	Wiring diagrams .....	13
	Wiring Diagrams - Single Phase .....	13
9	Sound data .....	14
	Sound Pressure Spectrum .....	14

# 1 Features

For wide rooms with no false ceilings nor free floor space

- Ideal for comfortable air flow in wide rooms thanks to Coanda effect: up to 100° discharge angle
- Even rooms with ceilings up to 3.8m can be heated up or cooled down very easily without capacity loss
- Can easily be installed in both new and refurbishment projects
- Unified indoor unit can be combined with R-32 and R-410A outdoor units, simplifying stock
- Combining with R-32 Bluevolution technology, reduces environmental impact with 68% compared to R-410A, leads directly to lower energy consumption thanks to its high energy efficiency and has up to lower 16% refrigerant charge
- Can easily be mounted in corners and narrow spaces, as it only needs 30mm lateral service space
- 5 different fan speeds available for maximum comfort
- Reduced energy consumption thanks to specially developed small tube heat exchanger, DC fan motor and drain pump
- Stylish unit blends easily with any interior. The flaps close entirely when the unit is not operating and there are no air intake grilles visible



Infrastructure cooling



Home leave operation



Fan only



Auto cooling-heating changeover



Vertical auto swing



Fan speed steps



Dry programme



Air filter



Weekly timer



Infrared remote control



Wired remote control



Centralised control



Auto-restart



Self diagnosis



Drain pump kit



Twin/triple/double twin application



Multi model application

## 2 Specifications

2-1 Technical Specifications				FHA35A	FHA50A	FHA60A	FHA71A	FHA100A	FHA125A	FHA140A	
Power input - 50Hz	Cooling	Nom.	kW	0.090		0.091	0.110	0.344	0.360	0.380	
	Heating	Nom.	kW	0.090		0.091	0.110	0.344	0.360	0.380	
Casing	Colour	White									
	Material	Resin, sheet metal									
Dimensions	Unit	Height/Width/Depth	mm	235/960/690		235/1,270/690		235/1,590/690			
	Packed unit	Height/Width/Depth	mm	340/1,116/858		349/1,426/878		349/1,746/878			
Weight	Unit			kg	24.0	25.0	31.0	32.0	38.0		
	Packed unit			kg	38	39	52	54	61		
Heat exchanger	Fin	Type	ML fin (Anti Corrosion Hydrophilic)								
Air filter	Type	Resin net									
Fan	Type	Sirocco fan									
	Quantity				2		3		4		
Air flow rate	Cooling	High	m <sup>3</sup> /min	14.0	15.0	19.5	20.5	28.0	31.0	34.0	
			cfm	494	530	689	724	989	1,095	1,201	
		Medium	m <sup>3</sup> /min	11.5 (1)	12.0 (1)	15.0 (1)	17.0 (1)	24.0 (1)	27.0 (1)	29.0 (1)	
			cfm	406	424	530	600	848	953	1,024	
		Low	m <sup>3</sup> /min	10.0		11.5	14.0	20.0	23.0	24.0	
			cfm	353		406	494	706	812	848	
	Heating	High	m <sup>3</sup> /min	14.0	15.0	19.5	20.5	28.0	31.0	34.0	
			cfm	494	530	689	724	989	1,095	1,201	
		Medium	m <sup>3</sup> /min	11.5 (1)	12.0 (1)	15.0 (1)	17.0 (1)	24.0 (1)	27.0 (1)	29.0 (1)	
			cfm	406	424	530	600	848	953	1,024	
		Low	m <sup>3</sup> /min	10.0		11.5	14.0	20.0	23.0	24.0	
			cfm	353		406	494	706	812	848	
Fan motor	Quantity	1									
	Model				KFD-280-87-8A		KFD-280-117-8A		EQDW01EDK		
	Speed	Steps	5								
	Output	High	W	60		91		150			
	Full load amps (FLA)	Cooling	A	0.6			0.8	1.2	1.6	1.8	
		Heating	A	0.6			0.8	1.2	1.6	1.8	
Sound power level	Cooling			dBA	53	54	55	60	62	64	
	Heating			dBA	-						
Sound pressure level	Cooling	High/Medium/Low	dBA	36/34 (1)/31	37/35 (1)/32	37/35 (1)/33	38/36 (1)/34	42/38 (1)/34	44/41 (1)/37	46/42 (1)/38	
	Heating	High/Nom./Medium	dBA	36/34/31	37/35/32	37/35/33	38/36/34	42/38/34	44/41/37	46/42/38	
Control systems	Infrared remote control	BRC7GA53 / BRC7GA56									
	Wired remote control	BRC1E53A7 / BRC1E53B7 / BRC1E53C7 / BRC1D528 / BRC1E51A7									
Refrigerant	Type	R-32 / R-410A									
Piping connections	Sound absorbing insulation	Not needed									
	Liquid	Type/OD	mm	Flare connection/6,4			Flare connection/9,52				
	Gas	Type/OD	mm	Flare connection/9.50	Flare connection/12.7		Flare connection/15.9				
	Drain	VP20									
	Heat insulation	Needed									
Safety devices	Item	01/02	Fuse (F, 5A, 250V)/Fan motor fuse (F,4A,500V)				Fuse (F, 5A, 250V)/-				

Standard Accessories : Thermal insulation tube; Quantity : 2;

Standard Accessories : Wire clamp material; Quantity : 7;

Standard Accessories : Hose band; Quantity : 1;

Standard Accessories : Drain hose; Quantity : 1;

Standard Accessories : Washer; Quantity : 8;

Standard Accessories : Sealing pad (large); Quantity : 1;

Standard Accessories : Sealing pad (small); Quantity : 1;

## 2 Specifications

Standard Accessories : Resin bushing; Quantity : 1;

Standard Accessories : Screws; Quantity : 2;

Standard Accessories : Wiring fixture; Quantity : 2;

2

2-2 Electrical Specifications			FHA35A	FHA50A	FHA60A	FHA71A	FHA100A	FHA125A	FHA140A
Power supply	Phase		1~						
	Frequency	Hz	50						
	Voltage	V	220-240						

### Notes

(1) See separate drawing for electrical data

### 3 Safety device settings

#### 3 - 1 Safety Device Settings

## FHA-A

Safety devices	FHA35-50AVEB	FHA60-71AVEB
Printed circuit board fuse (main)	250V, 3.15A	250V, 3.15A
Fuse (fan motor)	500V, 4A (on wire)	500V, 4A (on wire)
Fan motor overcurrent protection (nom.)	1.65A	1.65A
Fan motor overheat protection (max.)	125°C	125°C

Safety devices	FHA100-140AVEB
Printed circuit board fuse (main)	250V, 3.15A
Fuse (fan motor)	---
Fan motor overcurrent protection (nom.)	2.3A
Fan motor overheat protection (max.)	125°C

**4D110679**

# 4 Options

## 4 - 1 Options

4

### FHA-A

Option kit	Capacity class						
	35	50	60	71	100	125	140
Long-life replacement filter	KAFP501A56		KAFP501A80		KAFP501A160		
Fresh air intake kit	KDDQ50A140						
Drain pump kit	KDUP50Q63			KDUP50Q160			
L-type piping kit (upward direction)	KHFP5MA35	KHFP5N63		KHFP5N160			
Remote control	BRC1E53A7 <sup>(1)(4)</sup> , BRC1E53B7 <sup>(2)(4)</sup> , BRC1E53C7 <sup>(3)(4)</sup> , BRC1E51A7, BRC1D528						
	Wired remote control	Wireless remote control		Heat pump		BRC7GA53	
			Cooling only		BRC7GA56		
Simplified remote control (with operation mode selector button)	BRC2E52C7 <sup>(5)</sup>						
Simplified remote control (without operation mode selector button)	BRC3E52C7 <sup>(5)</sup>						
Central remote control	DCS302CA51						
Unified ON/OFF controller	DCS301BA51						
Schedule timer	DST301BA51						
Wiring adaptor for electrical appendices	KRP1BA54 <sup>(6)</sup>						
Wiring adaptor for electrical appendices	KRP4AA52 <sup>(6)</sup>						
Installation box for adaptor PCB	KRP1D93A						
Mounting plate for adaptor PCB installation box	KKSAP50A56						
Remote sensor	KRCS01-4B						
Remote "ON/OFF" and "forced OFF" kit	EKRORO4						
Electrical box with earth terminal (3 blocks)	KJB311AA						
Electrical box with earth terminal (2 blocks)	KJB212AA						
Digital input adaptor	BRP7A52 <sup>(6)(7)</sup>						

- ① Included languages are: English, German, French, Italian, Spanish, Portuguese, and Dutch.
- ② Included languages are: English, Czech, Croatian, Hungarian, Slovenian, Romanian, and Bulgarian.
- ③ Included languages are: English, Russian, Greek, Turkish, Polish, Albanian, and Slovak.
- ④ Includes duty rotation functionality
- ⑤ Included languages are:  
 Language pack 1: English, German, French, Dutch, Spanish, Italian, and Portuguese.  
 With PC cable EKPCAB3 in combination with the Updater PC software, you can additionally change the language to:  
 Language pack 2: English, Bulgarian, Croatian, Czech, Hungarian, Romanian, and Slovenian.  
 Language pack 3: English, Greek, Polish, Russian, Serbian, Slovak, and Turkish.
- ⑥ Requires installation box 6.
- ⑦ Only possible in combination with simplified remote control BRC2/3E52C7.

**3D109746A**



# 5 Dimensional drawings

## 5 - 1 Dimensional Drawings

### FHA-A

**Remote control dimensions**

**Receiver installation procedure**

**Receiver detail**

**3D109659**

### FHA35A

**Notes**

- 1) Location of nameplate  
Bottom of the fan housing inside the suction grille
- 2) When installing a wireless controller, there will be a receiver on this location. For details, see the drawing of the wireless controller.
- 3) Do not place any objects under the indoor unit. In case of high humidity (>80%), clogged drain outlets, or dirty air filters, condensate may drop out.

Number	Name	Description
1	Air discharge grille	
2	Air suction grille	
3	Air filter	
4	Gas pipe connection Ø9.5 flare	
5	Liquid pipe connection Ø6.4 flare	
6	Drain pipe connection	Ø20
7	Terminal block with earth terminal	Located inside of the unit
8	Metal hanger	
9	Position of knockout hole	Rear side
10	Position of knockout hole	Top
11	Piping intake (right)	Knockout hole
12	Drain piping intake (left-rear)	Knockout hole
13	Drain piping intake (left)	Knockout hole
14	Drain piping intake (right)	Knockout hole
15	Standard location of holes in the wall Piping intake (rear)	Ø100
16	Drain piping intake (top)	Ø20
17	Gas piping intake (top)	Ø36
18	Liquid piping intake (top)	Ø26
19	Power supply wiring and control wiring intake (rear)	Ø29
20	Power supply wiring and control wiring intake (top)	Ø29

**3D106574A**

# 5 Dimensional drawings

## 5 - 1 Dimensional Drawings

5

### FHA50A

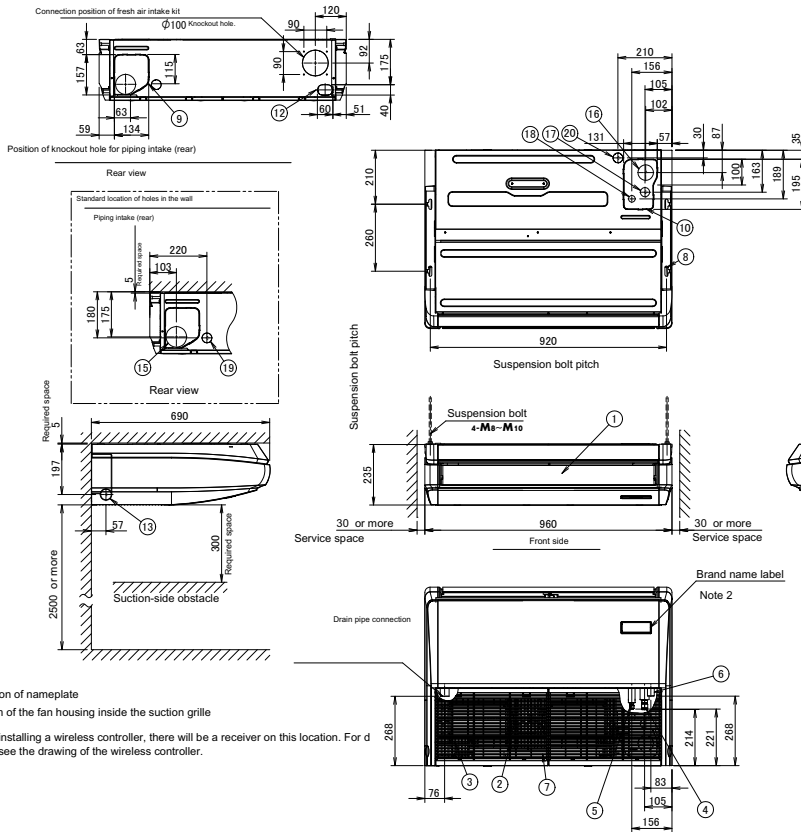

Number	Name	Description
1	Air discharge grille	
2	Air suction grille	
3	Air filter	
4	Gas pipe connection Ø12.7 flare	
5	Liquid pipe connection Ø6.4 flare	
6	Drain pipe connection	VP20
7	Terminal block with earth terminal Located inside of the unit	#4
8	Metal hanger	
9	Position of knockout hole	Rear side
10	Position of knockout hole	Top
11	Piping intake (right)	Knockout hole
12	Drain piping intake (left-rear)	Knockout hole
13	Drain piping intake (left)	Knockout hole
14	Drain piping intake (right)	Knockout hole
15	Standard location of holes in the wall Piping intake (rear)	Ø100
16	Drain piping intake (top)	Ø40
17	Gas piping intake (top)	Ø26
18	Liquid piping intake (top)	Ø26
19	Power supply wiring and control wiring intake (rear)	Ø23
20	Power supply wiring and control wiring intake (top)	Ø23

Notes

- 1) Location of nameplate  
Bottom of the fan housing inside the suction grille
- 2) When installing a wireless controller, there will be a receiver on this location. For details, see the drawing of the wireless controller.
- 3) Do not place any objects under the indoor unit. In case of high humidity (>80%), clogged drain outlets, or dirty air filters, condensate may drop out.

3D109224A

### FHA60A

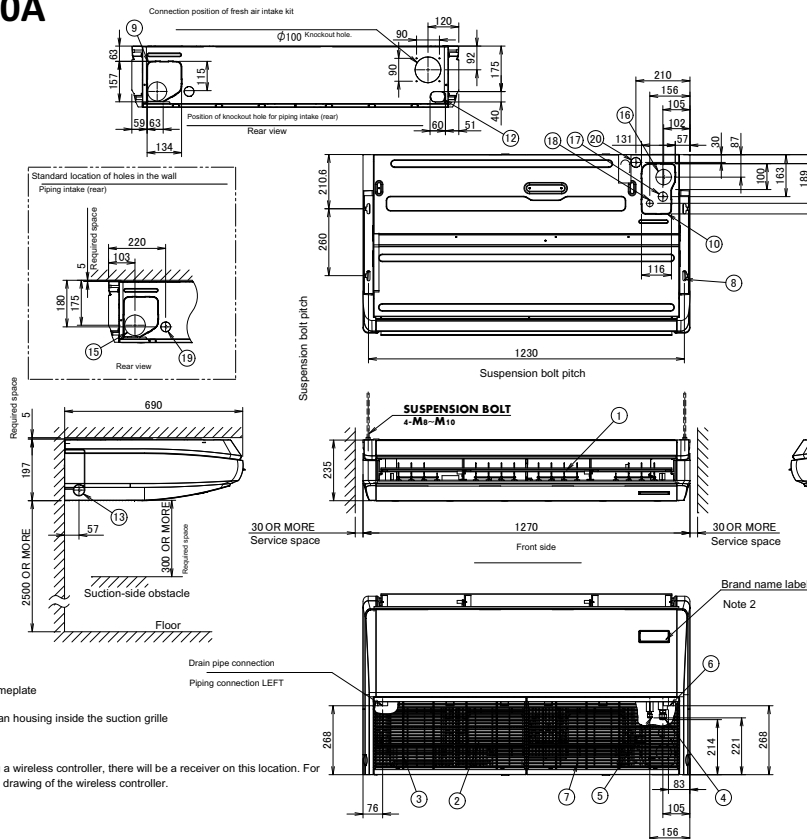

Number	Name	Description
1	Air discharge grille	
2	Air suction grille	
3	Air filter	
4	Gas pipe	Ø12.7 FLARE
5	Liquid pipe	Ø6.4 FLARE
6	Drain pipe connection	VP20
7	Terminal block with earth terminal Located inside of the unit	#4
8	Metal hanger	
9	Position of knockout hole	Rear side
10	Position of knockout hole	Top
11	Piping intake (right)	Knockout hole
12	Drain piping intake (left-rear)	Knockout hole
13	Drain piping intake (left)	Knockout hole
14	Drain piping intake (right)	Knockout hole
15	Standard location of holes in the wall Piping intake (rear)	Ø100
16	Drain piping intake (top)	Ø40
17	Gas piping intake (top)	Ø26
18	Liquid piping intake (top)	Ø26
19	Power supply wiring and control wiring intake (rear)	Ø23
20	Power supply wiring and control wiring intake (top)	Ø23

Notes

- 1) Location of nameplate  
Bottom of the fan housing inside the suction grille
- 2) When installing a wireless controller, there will be a receiver on this location. For details, see the drawing of the wireless controller.
- 3) Do not place any objects under the indoor unit. In case of high humidity (>80%), clogged drain outlets, or dirty air filters, condensate may drop out.

3D106552

8

# 5 Dimensional drawings

## 5 - 1 Dimensional Drawings

### FHA71A

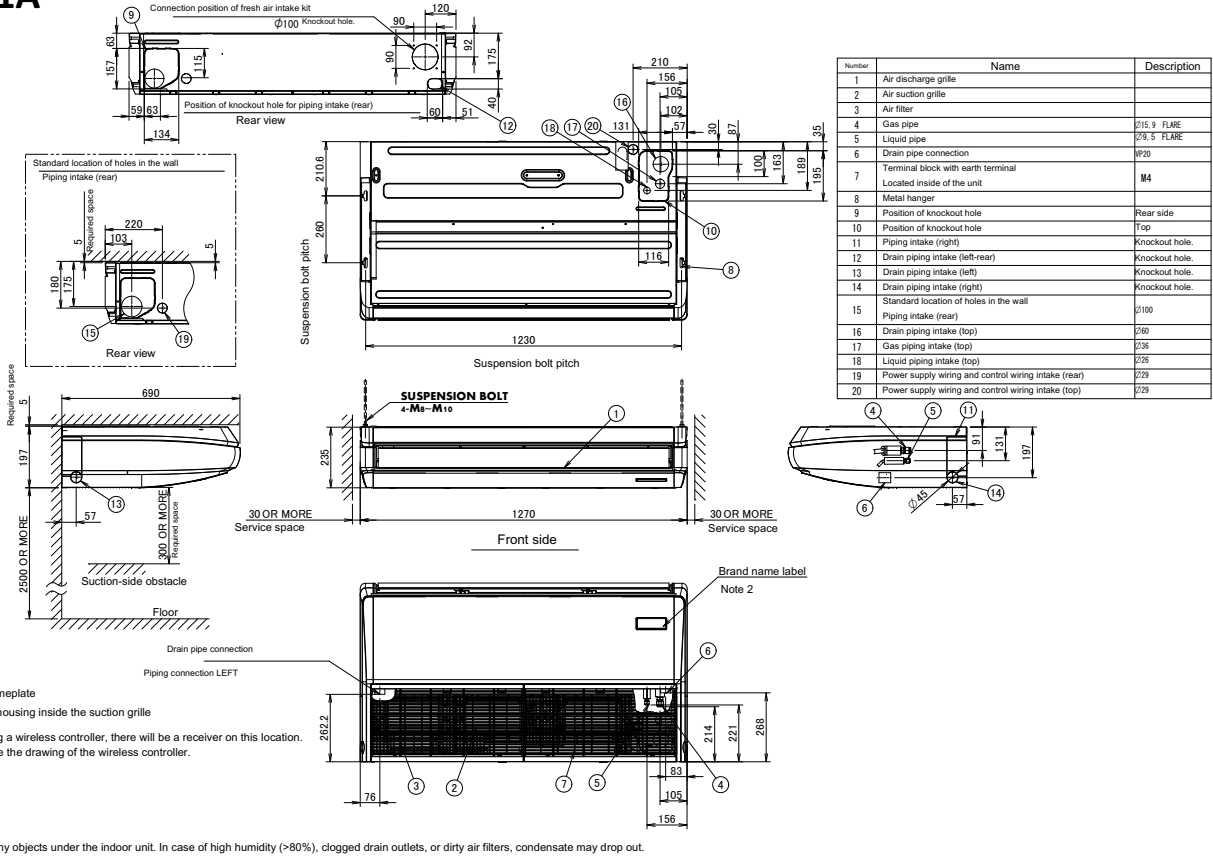

3D109222

### FHA100-140A

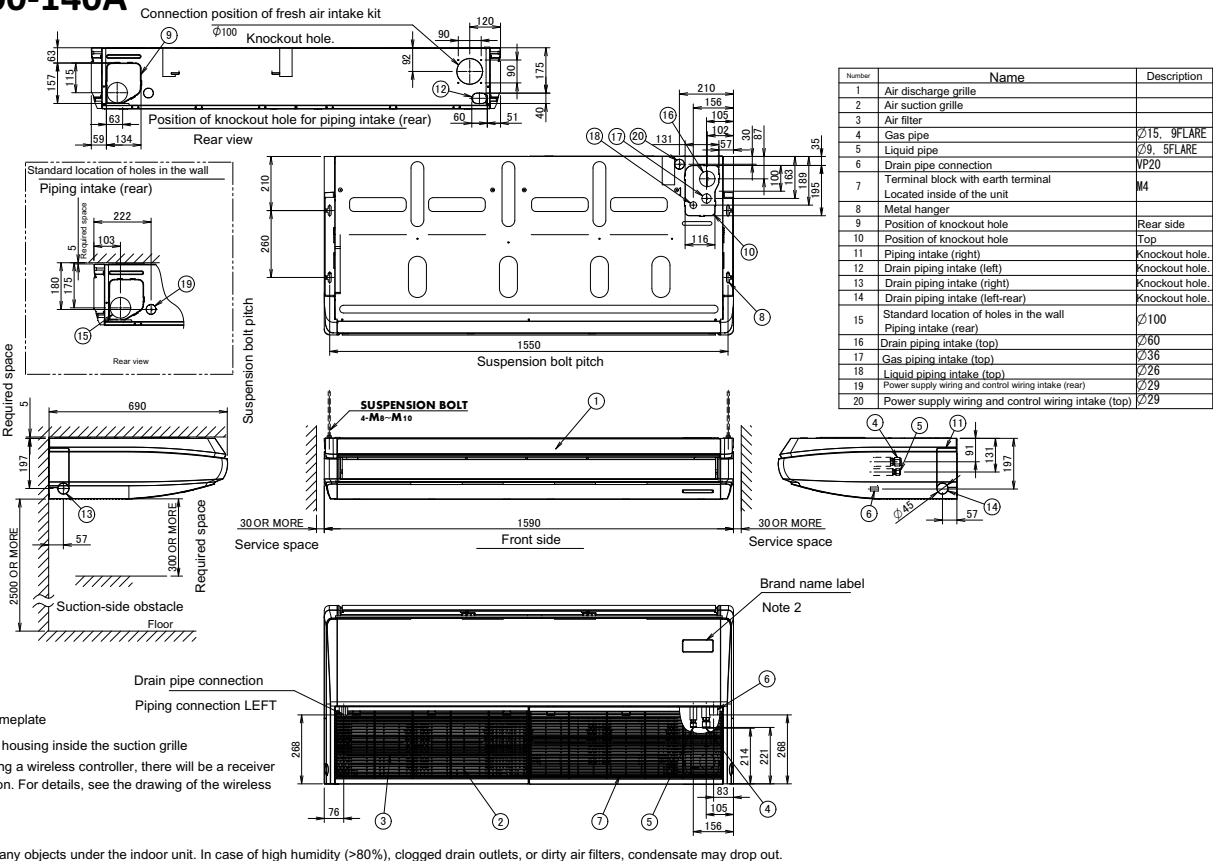

3D106530A

## 6 Centre of gravity

### 6 - 1 Centre of Gravity

6

#### FHA35-50A

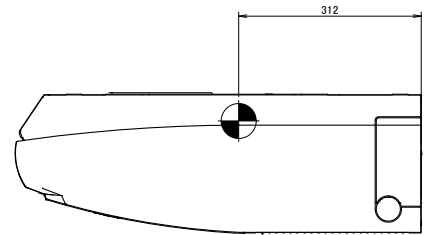
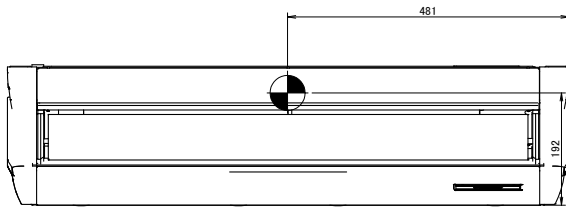

3D106833

#### FHA60-71A

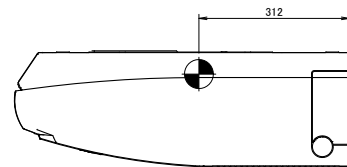
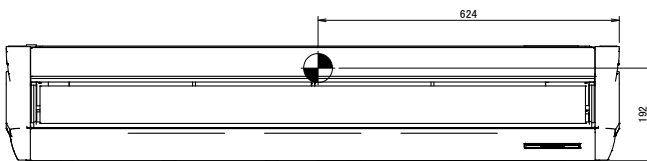

3D106836

## 6 Centre of gravity

### 6 - 1 Centre of Gravity

FHA100-140A

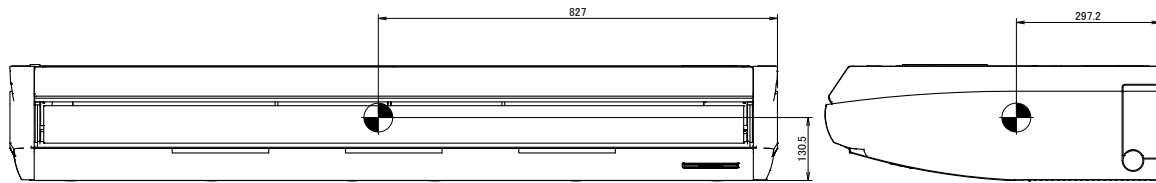

3D109249

# 7 Piping diagrams

## 7 - 1 Piping Diagrams

7

### FHA-A

Model	A (mm)	B (mm)
FHA35AVEB	6.4	9.5
FHA50, 60AVEB		12.7
FHA71, 100, 125, 140AVEB	9.5	15.9

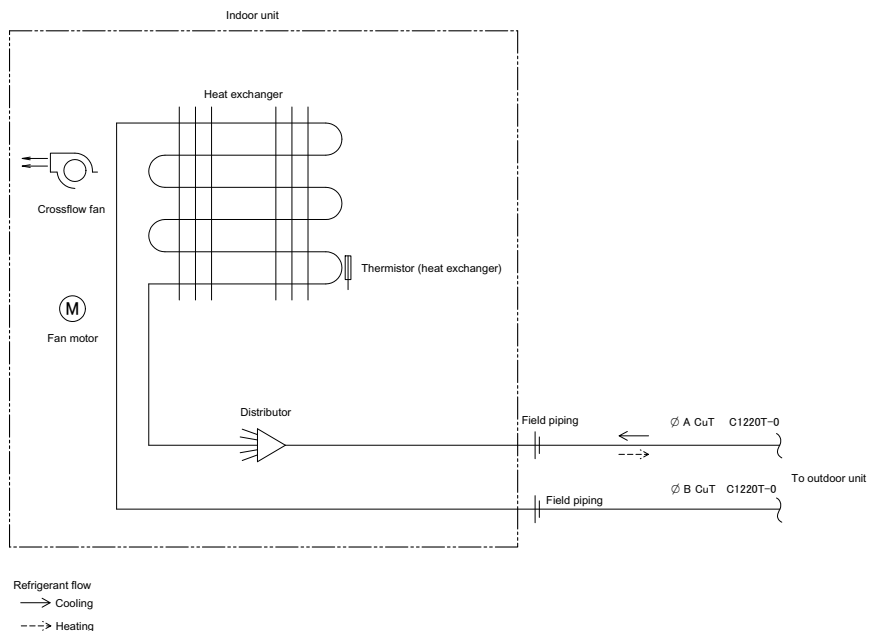

3D106495

# 8 Wiring diagrams

## 8 - 1 Wiring Diagrams - Single Phase

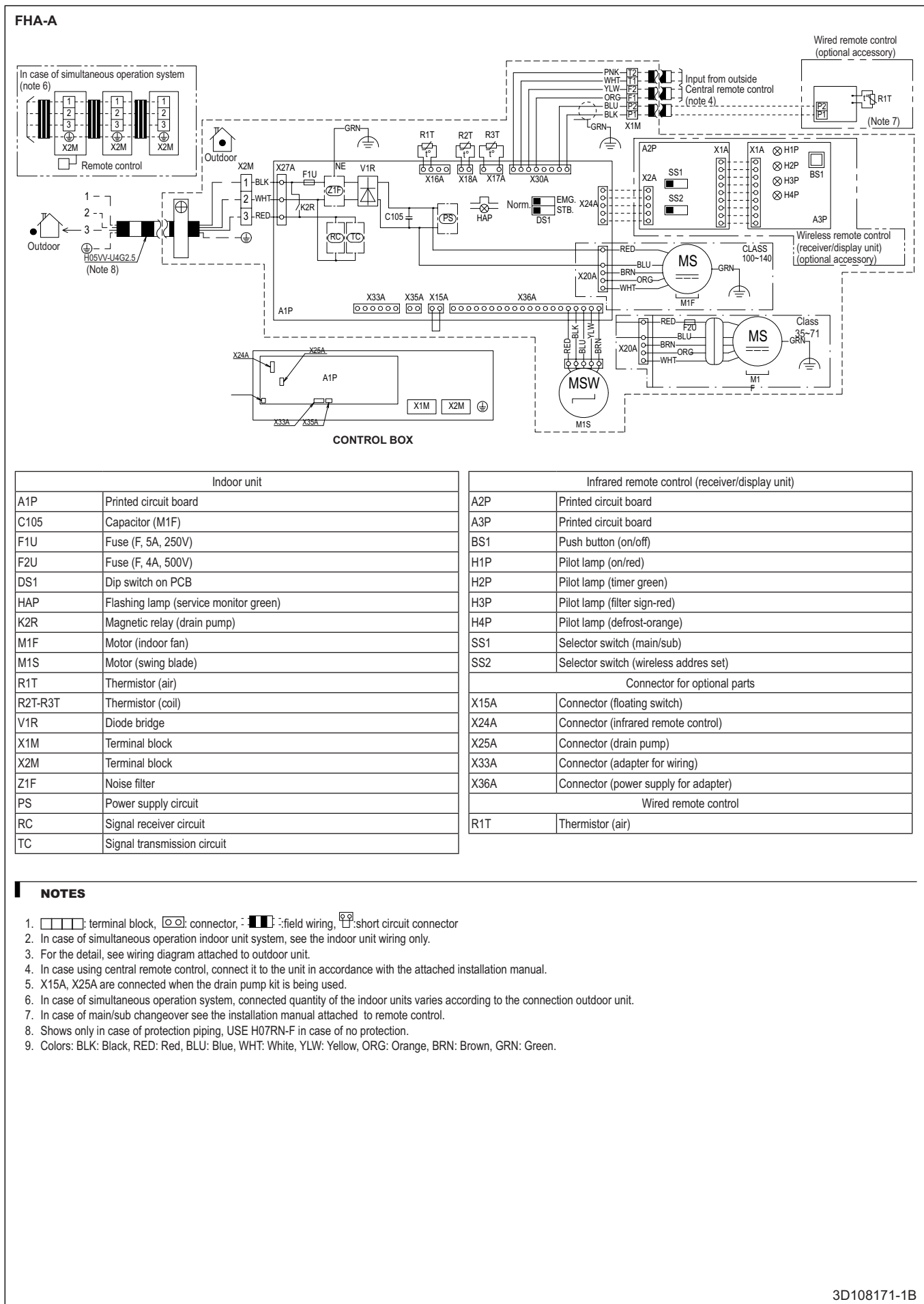

**NOTES**

- : terminal block, □○□: connector, - ■■■: field wiring, □□: short circuit connector
- In case of simultaneous operation indoor unit system, see the indoor unit wiring only.
- For the detail, see wiring diagram attached to outdoor unit.
- In case using central remote control, connect it to the unit in accordance with the attached installation manual.
- X15A, X25A are connected when the drain pump kit is being used.
- In case of simultaneous operation system, connected quantity of the indoor units varies according to the connection outdoor unit.
- In case of main/sub changeover see the installation manual attached to remote control.
- Shows only in case of protection piping, USE H07RN-F in case of no protection.
- Colors: BLK: Black, RED: Red, BLU: Blue, WHT: White, YLW: Yellow, ORG: Orange, BRN: Brown, GRN: Green.

# 9 Sound data

## 9 - 1 Sound Pressure Spectrum

9

### FHA35A

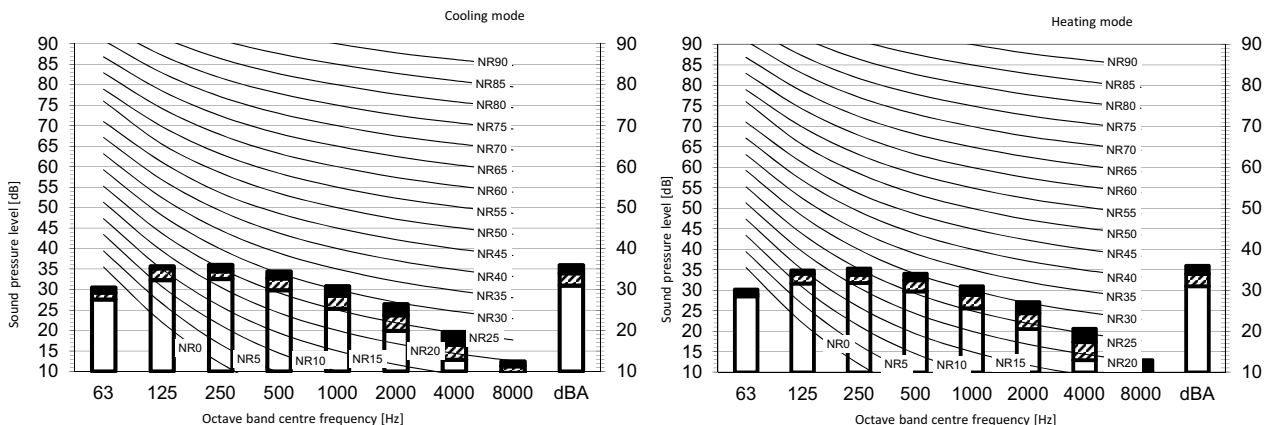

Legend  
dBA = A-weighted sound pressure level (A scale according to IEC).

A Scale Fan speed

B High  
C Medium  
D Low

Location of microphone

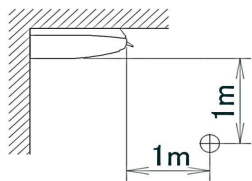

Cooling Total dB				Heating Total dB			
A	B	C	D	A	B	C	D
dBA	36	34	31	dBA	36	34	31

Notes

- Operating conditions: power source 220-240 V/220 V 50/60 Hz; JIS standard
- Background noise already taken into account.
- Operating noise varies depending on operation and ambient conditions.
- The operation noise measuring method is in accordance with JISC9612.
- Measuring location: anechoic chamber

3D109743

### FHA50A

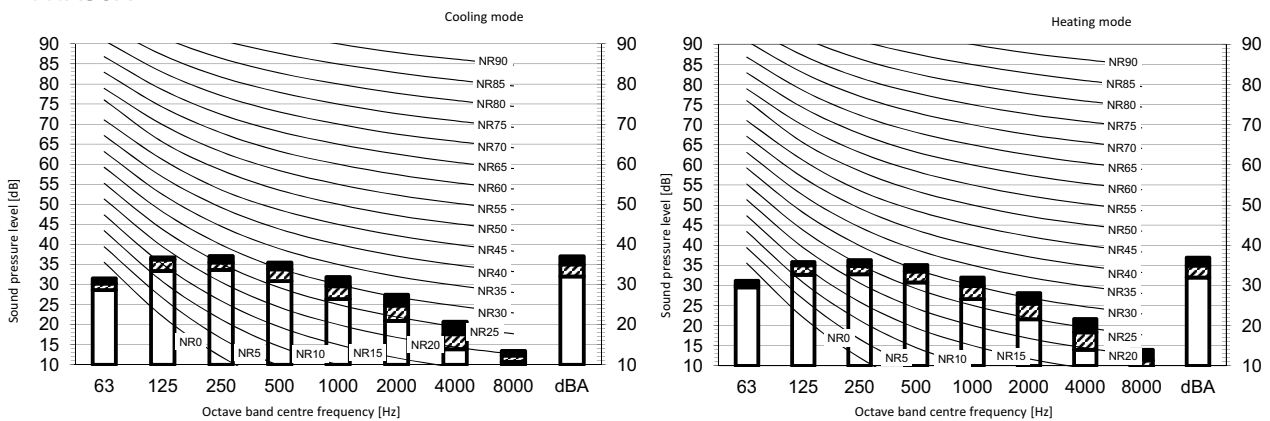

Legend  
dBA = A-weighted sound pressure level (A scale according to IEC).

A Scale Fan speed

B High  
C Medium  
D Low

Location of microphone

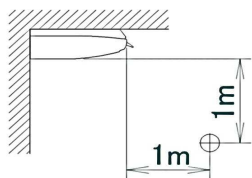

Cooling Total dB				Heating Total dB			
A	B	C	D	A	B	C	D
dBA	37	35	32	dBA	37	35	32

Notes

- Operating conditions: power source 220-240 V/220 V 50/60 Hz; JIS standard
- Background noise already taken into account.
- Operating noise varies depending on operation and ambient conditions.
- The operation noise measuring method is in accordance with JISC9612.
- Measuring location: anechoic chamber

3D109742



# 9 Sound data

## 9 - 1 Sound Pressure Spectrum

### FHA60A

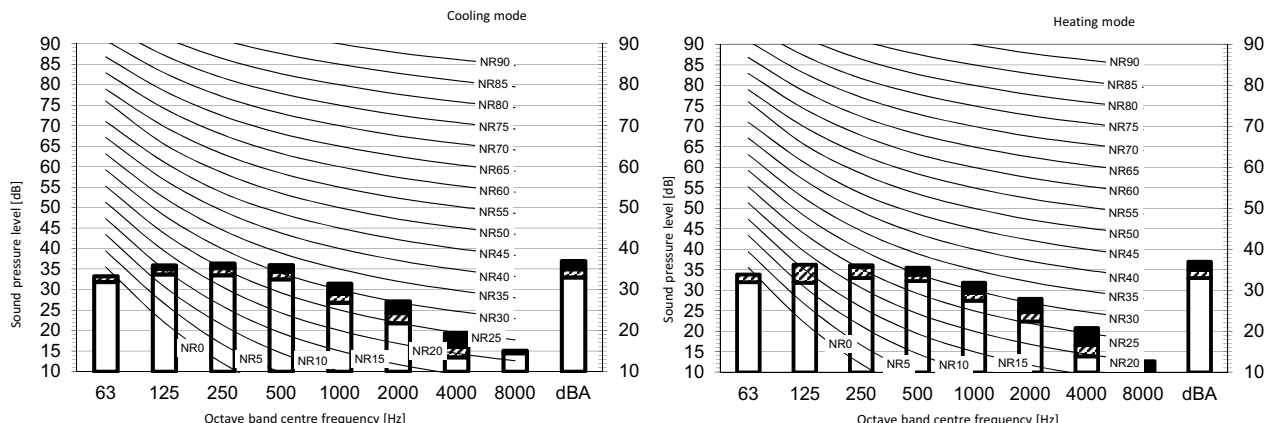

**Legend**

dBA = A-weighted sound pressure level (A scale according to IEC).

A Scale Fan speed

- B High
- C Medium
- D Low

Location of microphone

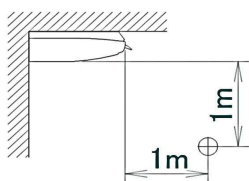

Cooling Total dB				Heating Total dB			
A	B	C	D	A	B	C	D
dBA	37	35	33	dBA	37	35	33

**Notes**

1. Operating conditions: power source 220-240 V/220 V 50/60 Hz; JIS standard
2. Background noise already taken into account.
3. Operating noise varies depending on operation and ambient conditions.
4. The operation noise measuring method is in accordance with JISC9612.
5. Measuring location: anechoic chamber

**3D109741**

### FHA71A

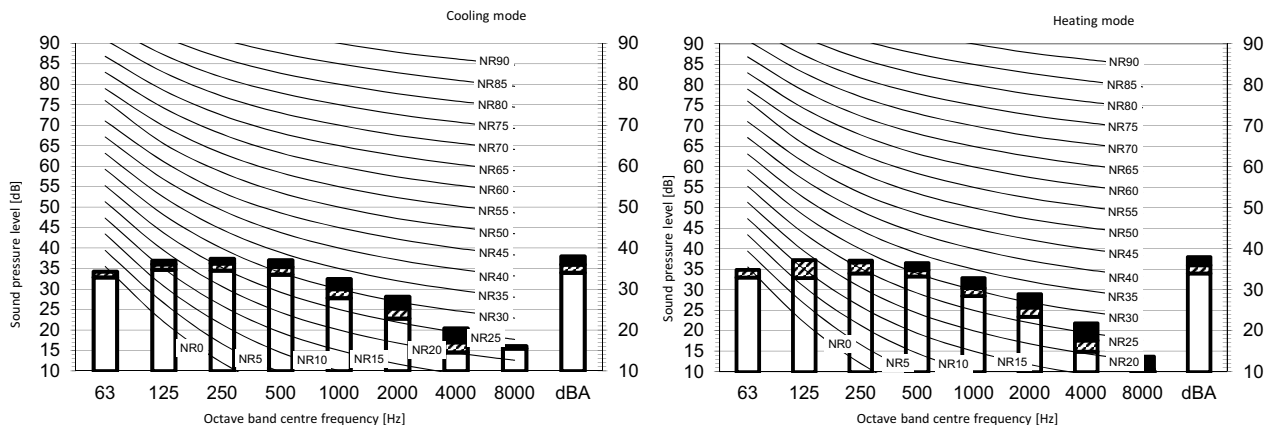

**Legend**

dBA = A-weighted sound pressure level (A scale according to IEC).

A Scale Fan speed

- B High
- C Medium
- D Low

Location of microphone

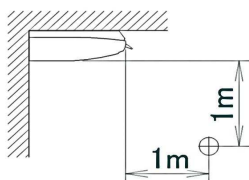

Cooling Total dB				Heating Total dB			
A	B	C	D	A	B	C	D
dBA	38	36	34	dBA	38	36	34

**Notes**

1. Operating conditions: power source 220-240 V/220 V 50/60 Hz; JIS standard
2. Background noise already taken into account.
3. Operating noise varies depending on operation and ambient conditions.
4. The operation noise measuring method is in accordance with JISC9612.
5. Measuring location: anechoic chamber

**3D109736**

# 9 Sound data

## 9 - 1 Sound Pressure Spectrum

### FHA100A

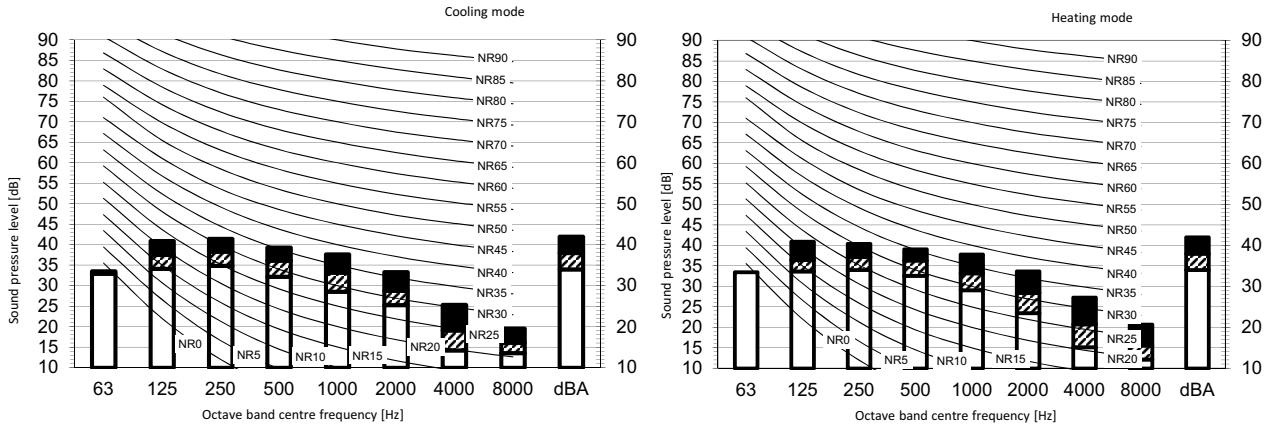

Legend  
dBA = A-weighted sound pressure level (A scale according to IEC).

- A Scale Fan speed
- B High
  - C Medium
  - D Low

Location of microphone

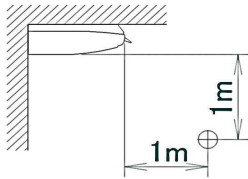

Cooling				Heating			
Total dB				Total dB			
A	B	C	D	A	B	C	D
dBA	42	38	34	dBA	42	38	34

- Notes
- Operating conditions: power source 220-240 V/220 V 50/60 Hz; JIS standard
  - Background noise already taken into account.
  - Operating noise varies depending on operation and ambient conditions.
  - The operation noise measuring method is in accordance with JISC9612.
  - Measuring location: anechoic chamber

3D109737

### FHA125A

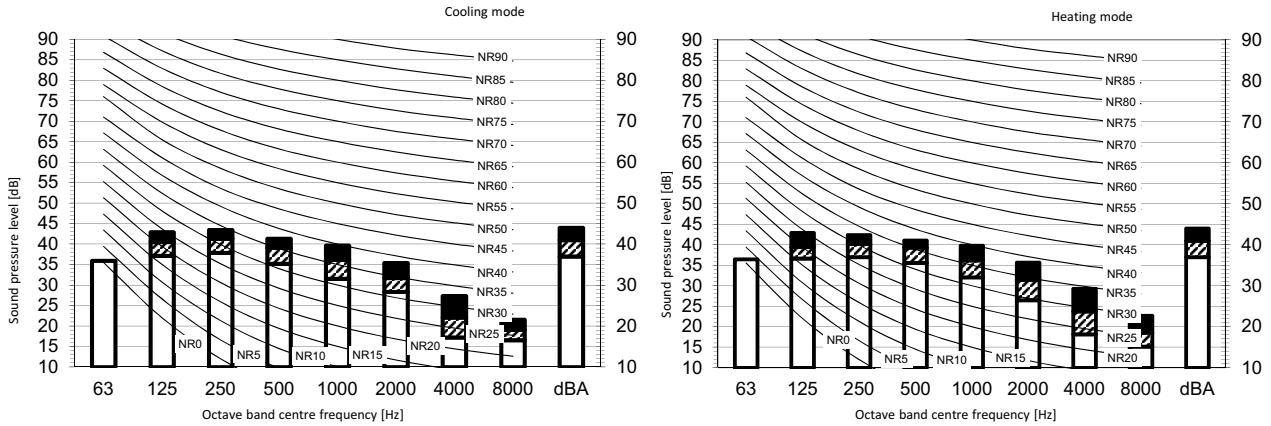

Legend  
dBA = A-weighted sound pressure level (A scale according to IEC).

- A Scale Fan speed
- B High
  - C Medium
  - D Low

Location of microphone

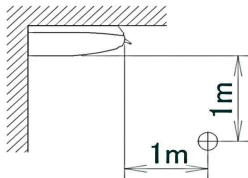

Cooling				Heating			
Total dB				Total dB			
A	B	C	D	A	B	C	D
dBA	44	41	37	dBA	44	41	37

- Notes
- Operating conditions: power source 220-240 V/220 V 50/60 Hz; JIS standard
  - Background noise already taken into account.
  - Operating noise varies depending on operation and ambient conditions.
  - The operation noise measuring method is in accordance with JISC9612.
  - Measuring location: anechoic chamber

3D109738

# 9 Sound data

## 9 - 1 Sound Pressure Spectrum

### FHA140A

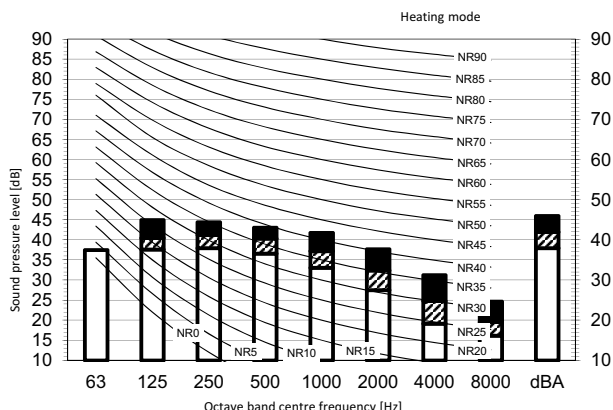
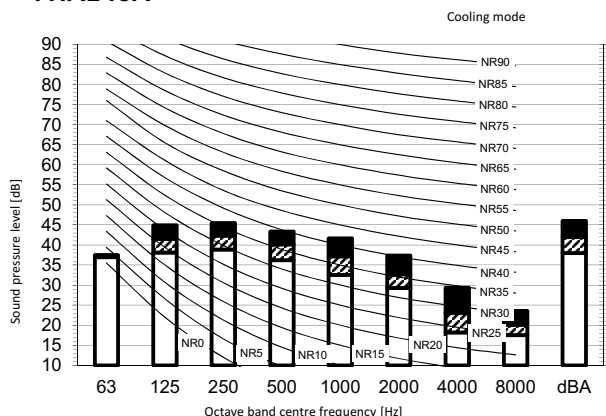

**Legend**

dBA = A-weighted sound pressure level (A scale according to IEC).

A Scale Fan speed

- B High
- C Medium
- D Low

Location of microphone

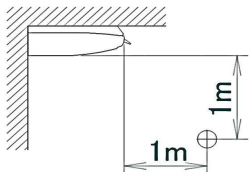

Cooling		Total dB	
A	B	C	D
dBA	46	42	38

Heating		Total dB	
A	B	C	D
dBA	46	42	38

**Notes**

1. Operating conditions: power source 220-240 V/220 V 50/60 Hz; JIS standard
2. Background noise already taken into account.
3. Operating noise varies depending on operation and ambient conditions.
4. The operation noise measuring method is in accordance with JISC9612.
5. Measuring location: anechoic chamber

**3D109740**





Daikin Europe N.V. Naamloze Vennootschap - Zandvoordestraat 300, B-8400 Oostende - Belgium - [www.daikin.eu](http://www.daikin.eu) - BE 0412 120 336 - RPR Oostende

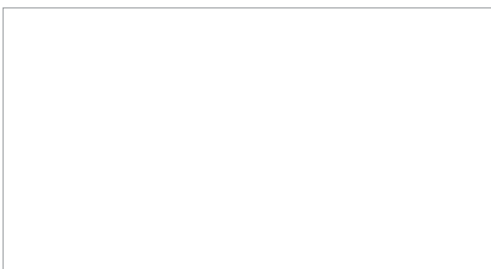

EEDEN17 07/17



Daikin Europe N.V. participates in the Eurovent Certification programme for Liquid Chilling Packages (LCP), Air handling units (AHU), Fan coil units (FCU) and variable refrigerant flow systems (VRF) Check ongoing validity of certificate online: [www.eurovent-certification.com](http://www.eurovent-certification.com) or using: [www.certiflash.com](http://www.certiflash.com)



The present leaflet is drawn up by way of information only and does not constitute an offer binding upon Daikin Europe N.V.. Daikin Europe N.V. has compiled the content of this leaflet to the best of its knowledge. No express or implied warranty is given for the completeness, accuracy, reliability or fitness for particular purpose of its content and the products and services presented therein. Specifications are subject to change without prior notice. Daikin Europe N.V. explicitly rejects any liability for any direct or indirect damage, in the broadest sense, arising from or related to the use and/or interpretation of this leaflet. All content is copyrighted by Daikin Europe N.V.