



Download the
ONECTA app
STAND BY ME
Discover our service offer



Operation manual

Daikin room air conditioner



CTXM15A2V1B
CTXM15A5V1B

FTXM20A2V1B
FTXM20A5V1B
FTXM25A2V1B
FTXM25A5V1B
FTXM35A2V1B
FTXM35A5V1B
FTXM42A2V1B
FTXM42A5V1B
FTXM50A2V1B
FTXM50A5V1B

Operation manual
Daikin room air conditioner

English

Table of contents

1	About the documentation	2
1.1	About this document.....	2
2	User safety instructions	2
2.1	General.....	2
2.2	Instructions for safe operation.....	3
3	About the system	5
3.1	Indoor unit.....	5
3.1.1	Daikin eye indication lamp.....	5
3.2	About the user interface.....	5
3.2.1	Components: Wireless remote control.....	6
4	Before operation	6
4.1	To insert the batteries.....	6
4.2	To mount the wireless remote control holder.....	6
4.3	To set the clock.....	6
4.4	To set the brightness of the Daikin eye.....	7
4.5	To turn on the power supply.....	7
5	Operation	7
5.1	Operation range.....	7
5.2	Operation mode and temperature setpoint.....	7
5.2.1	To start/stop operation mode and to set the temperature.....	8
5.3	Airflow rate.....	8
5.3.1	To adjust the airflow rate.....	8
5.4	Airflow direction.....	8
5.4.1	To adjust vertical airflow direction.....	8
5.4.2	To adjust horizontal airflow direction.....	8
5.4.3	To use 3D airflow direction.....	8
5.5	Comfort airflow and Intelligent eye operation.....	9
5.5.1	Comfort airflow operation.....	9
5.5.2	Intelligent eye operation.....	9
5.5.3	To start/stop Comfort and Intelligent eye operation.....	9
5.6	Powerful operation.....	9
5.6.1	To start/stop Powerful operation.....	9
5.7	Econo and Outdoor unit quiet operation.....	9
5.7.1	Econo operation.....	9
5.7.2	Outdoor unit quiet operation.....	9
5.7.3	To start/stop Econo and Outdoor unit quiet operation.....	10
5.8	Flash Streamer (air cleaning) operation.....	10
5.8.1	To start/stop Flash Streamer (air cleaning) operation.....	10
5.9	OFF/ON timer operation.....	10
5.9.1	24 hour clock OFF/ON timer setting.....	10
5.9.2	12 hour countdown OFF/ON timer setting.....	11
5.10	Weekly timer operation.....	11
5.10.1	To set Weekly timer operation.....	12
5.10.2	To copy reservations.....	12
5.10.3	To confirm reservations.....	12
5.10.4	To deactivate and reactivate Weekly timer operation.....	13
5.10.5	To delete reservations.....	13
5.11	Wireless LAN connection.....	13
5.11.1	Precautions when using the wireless LAN.....	13
5.11.2	To install the ONECTA app.....	13
5.11.3	To set the wireless connection.....	13
6	Energy saving and optimum operation	15
7	Maintenance and service	15
7.1	Overview: Maintenance and service.....	15
7.2	To clean the indoor unit and wireless remote control.....	16
7.3	To clean the front panel.....	16
7.4	To remove the front panel.....	16
7.5	To clean the air filters.....	16
7.6	To clean the titanium apatite deodorising filter and the silver particle filter (Ag-ion filter).....	17

7.7	To replace the titanium apatite deodorising filter and the silver particle filter (Ag-ion filter).....	17
7.8	To re-install the front panel.....	17

8	Troubleshooting	18
9	Disposal	18

1 About the documentation

1.1 About this document

Thank you for purchasing this product. Please:

- Keep the documentation for future reference.

Target audience

End users

INFORMATION

This appliance is intended to be used by expert or trained users in shops, in light industry, and on farms, or for commercial and household use by lay persons.

Documentation set

This document is part of a documentation set. The complete set consists of:

- **General safety precautions:**
 - Safety instructions that you must read before operating your system
 - Format: Paper (in the box of the indoor unit)
- **Operation manual:**
 - Quick guide for basic usage
 - Format: Paper (in the box of the indoor unit)
- **User reference guide:**
 - Detailed step-by-step instructions and background information for basic and advanced usage
 - Format: Digital files on <https://www.daikin.eu>. Use the search function  to find your model.

Latest revisions of the supplied documentation may be available on the regional Daikin website or via your installer.

Scan the QR code below to find the full documentation set and more information about your product on Daikin website.



The original instructions are written in English. All other languages are translations of the original instructions.

2 User safety instructions

Always observe the following safety instructions and regulations.

2.1 General

WARNING

If you are NOT sure how to operate the unit, contact your installer.

WARNING

This appliance can be used by children aged from 8 years and above and persons with reduced physical, sensory or mental capabilities or lack of experience and knowledge if they have been given supervision or instruction concerning use of the appliance in a safe way and understand the hazards involved.

Children **SHALL NOT** play with the appliance.

Cleaning and user maintenance **SHALL NOT** be made by children without supervision.

WARNING

To prevent electrical shocks or fire:

- Do **NOT** rinse the unit.
- Do **NOT** operate the unit with wet hands.
- Do **NOT** place any objects containing water on the unit.

CAUTION

- Do **NOT** place any objects or equipment on top of the unit.
- Do **NOT** sit, climb or stand on the unit.

- Units are marked with the following symbol:



This means that electrical and electronic products may **NOT** be mixed with unsorted household waste. Do **NOT** try to dismantle the system yourself: dismantling the system, treatment of the refrigerant, of oil and of other parts **MUST** be done by an authorised installer and **MUST** comply with applicable legislation.

Units **MUST** be treated at a specialised treatment facility for reuse, recycling and recovery. By ensuring this product is disposed of correctly, you will help to prevent potential negative consequences for the environment and human health. For more information, contact your installer or local authority.

- Batteries are marked with the following symbol:



This means that the batteries may **NOT** be mixed with unsorted household waste. If a chemical symbol is printed beneath the symbol, this chemical symbol means that the battery contains a heavy metal above a certain concentration.

Possible chemical symbols are: Pb: lead (>0.004%).

Waste batteries **MUST** be treated at a specialised treatment facility for reuse. By ensuring waste batteries are disposed of correctly, you will help to prevent potential negative consequences for the environment and human health.

2.2 Instructions for safe operation

A2L WARNING: MILDLY FLAMMABLE MATERIAL

The refrigerant inside this unit is mildly flammable.

CAUTION

The indoor unit contains radio equipment, minimum separation distance between the radiating part of the equipment and the user is 10 cm.

CAUTION

Do **NOT** insert fingers, rods or other objects into the air inlet or outlet. When the fan is rotating at high speed, it will cause injury.

WARNING

- Do **NOT** modify, disassemble, remove, reinstall or repair the unit yourself as incorrect dismantling or installation may cause an electrical shock or fire. Contact your dealer.
- In case of accidental refrigerant leaks, make sure there are no naked flames. The refrigerant itself is entirely safe, non-toxic and mildly flammable, but it will generate toxic gas when it accidentally leaks into a room where combustible air from fan heaters, gas cookers, etc. is present. Always have qualified service personnel confirm that the point of leakage has been repaired or corrected before resuming operation.

2 User safety instructions

CAUTION

ALWAYS use the wireless remote control or other user interface (if applicable) to adjust the position of the flaps and louvers. When the flaps and louvers are swinging and you move them forcibly by hand, the mechanism will break.

CAUTION

NEVER expose little children, plants or animals directly to the airflow.

WARNING

Do NOT place a flammable spray bottle near the air conditioner and do NOT use sprays near the unit. Doing so may result in a fire.

CAUTION

Do NOT operate the system when using a room fumigation-type insecticide. Chemicals could collect in the unit, and endanger the health of people who are hypersensitive to chemicals.

WARNING

- The refrigerant inside the unit is mildly flammable, but normally does NOT leak. If the refrigerant leaks in the room and comes in contact with fire from a burner, a heater, or a cooker, this may result in fire, or the formation of a harmful gas.
- Turn OFF any combustible heating devices, ventilate the room, and contact the dealer where you purchased the unit.
- Do NOT use the unit until a service person confirms that the part from which the refrigerant leaked has been repaired.

WARNING

- Do NOT pierce or burn refrigerant cycle parts.

- Do NOT use cleaning materials or means to accelerate the defrosting process other than those recommended by the manufacturer.
- Be aware that the refrigerant inside the system is odourless.

WARNING

The appliance shall be stored so as to prevent mechanical damage and in a well-ventilated room without continuously operating ignition sources (e.g. open flames, an operating gas appliance, or an operating electric heater). The room size shall be as specified in the General safety precaution.

DANGER: RISK OF ELECTROCUTION

To clean the air conditioner or air filter, be sure to stop operation and turn all power supplies OFF. Otherwise, an electrical shock and injury may result.

CAUTION

After a long use, check the unit stand and fitting for damage. If damaged, the unit may fall and result in injury.

CAUTION

Do NOT touch the heat exchanger fins. These fins are sharp and could result in cutting injuries.

WARNING

Be careful with ladders when working in high places.

WARNING

Improper detergents or cleaning procedure may cause damage on plastic components or water leakage. Splashed detergent on electric components, such as motors, may cause failure, smoke or ignition.

⚠ DANGER: RISK OF ELECTROCUTION

Before cleaning, be sure to stop the operation, turn the breaker OFF or pull out the supply cord. Otherwise, an electrical shock and injury may result.

⚠ WARNING

Stop operation and shut OFF the power if anything unusual occurs (burning smells etc.).

Leaving the unit running under such circumstances may cause breakage, electrical shock or fire. Contact your dealer.

⚠ WARNING

If the supply cord is damaged, it **MUST** be replaced by the manufacturer, its service agent or similarly qualified persons in order to avoid a hazard.

3 About the system

A2L WARNING: MILDLY FLAMMABLE MATERIAL
The refrigerant inside this unit is mildly flammable.

⚠ CAUTION
The indoor unit contains radio equipment, minimum separation distance between the radiating part of the equipment and the user is 10 cm.

ⓘ NOTICE
Do NOT use the system for other purposes. In order to avoid any quality deterioration, do NOT use the unit for cooling precision instruments, food, plants, animals, or works of art.

3.1 Indoor unit

⚠ CAUTION
Do NOT insert fingers, rods or other objects into the air inlet or outlet. When the fan is rotating at high speed, it will cause injury.

ⓘ INFORMATION
The sound pressure level is less than 70 dBA.

⚠ WARNING

- Do NOT modify, disassemble, remove, reinstall or repair the unit yourself as incorrect dismantling or installation may cause an electrical shock or fire. Contact your dealer.
- In case of accidental refrigerant leaks, make sure there are no naked flames. The refrigerant itself is entirely safe, non-toxic and mildly flammable, but it will generate toxic gas when it accidentally leaks into a room where combustible air from fan heaters, gas cookers, etc. is present. Always have qualified service personnel confirm that the point of leakage has been repaired or corrected before resuming operation.

ⓘ INFORMATION

The following figures are just examples and may NOT completely match your system layout.

ON/OFF button

If the user interface (e.g. wireless remote control) is missing, you can use the ON/OFF button on the indoor unit to start/stop operation. When operation is started using this button, the following settings are used:

- Operation mode = Automatic
- Temperature setting = 25°C
- Airflow rate = Automatic

3.1.1 Daikin eye indication lamp

The Daikin eye colour will change according to operation.

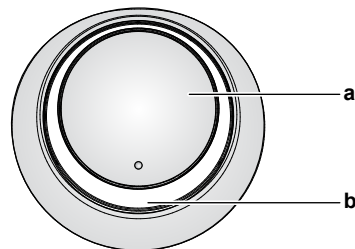

a ON/OFF button
b Daikin eye (with infrared signal receiver)

Operation	Daikin eye colour
Automatic	Red/blue
Cooling	Blue
Heating	Red
Fan only	White
Drying	Green
Timer operation	Orange ^(a)

^(a) When the OFF/ON timer or Weekly timer operation is set, the Daikin eye periodically changes to orange. After lighting orange for about 10 seconds, it returns to the colour of the operation mode for 3 minutes. **Example:** When the timer is set during cooling operation, the Daikin eye will periodically light orange for 10 seconds, and then switch to blue for 3 minutes.

3.2 About the user interface

Wireless remote control

ⓘ INFORMATION

The indoor unit is delivered with the wireless remote control as the user interface. This manual describes only operation with this user interface. If another user interface is connected, refer to the operation manual of the connected user interface.

4 Before operation

- **Direct sunlight.** Do NOT expose the wireless remote control to direct sunlight.
- **Dust.** Dust on the signal transmitter or receiver will reduce sensitivity. Wipe off dust with a soft cloth.
- **Fluorescent lights.** Signal communication might be disabled if fluorescent lamps are in the room. In that case, contact your installer.
- **Other appliances.** If the wireless remote control signals operate other appliances, move the other appliances, or contact your installer.
- **Curtains.** Make sure that curtains or other objects do NOT block the signal between the unit and the wireless remote control.

NOTICE

- Do NOT drop the wireless remote control.
- Do NOT let the wireless remote control get wet.

3.2.1 Components: Wireless remote control

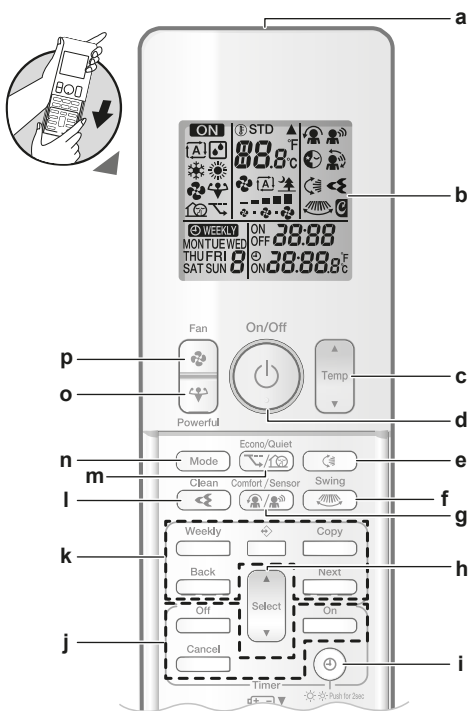

- a Signal transmitter
- b LCD display
- c Temperature adjustment button
- d ON/OFF button
- e Vertical swing button
- f Horizontal swing button
- g Comfort airflow and Intelligent eye operation button
- h Select button
- i Clock and indoor unit display brightness button
- j OFF/ON timer operation buttons
- k Weekly timer operation buttons
- l Flash Streamer (air cleaning) operation button
- m Econo and Outdoor unit quiet operation button
- n Mode button
- o Powerful button
- p Fan button

4 Before operation

4.1 To insert the batteries

The batteries will last for about 1 year.

- 1 Remove the front cover.

- 2 Insert both batteries at once.
- 3 Put back the front cover.

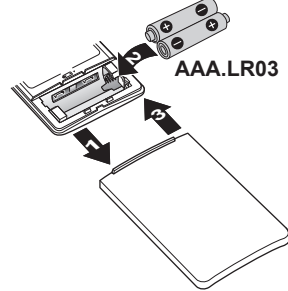

INFORMATION

- Low energy of battery is indicated by flashing of LCD display.
- ALWAYS replace both batteries at once.

4.2 To mount the wireless remote control holder

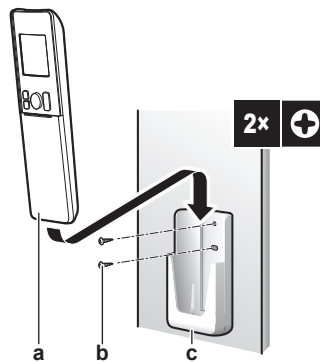

- a Wireless remote control
- b Screws (field supply)
- c Wireless remote control holder

- 1 Choose a place where the signals reach the unit.
- 2 Attach the holder with screws to the wall or a similar location.
- 3 Hang the wireless remote control on the holder.

4.3 To set the clock

Note: If the time is NOT set, MON, ☉, and 0:00 blink.

- 1 Press ☉.

Result: MON and ☉ blink

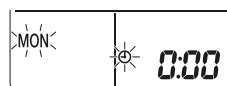

- 2 Press or to set the current day of the week.

- 3 Press ☉.

Result: ☉ blinks.

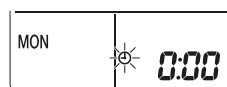

- 4 Press or to set the correct time.

Note: Holding down or increases or decreases the time setting rapidly.

- 5 Press ☉.

Result: Setting is complete.  blinks.

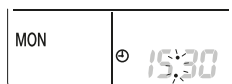

4.4 To set the brightness of the Daikin eye

- 1 Keep pressed  for at least 2 seconds every time you need to change the setting.

Result: Brightness will be changed in order: high, low, off.

4.5 To turn on the power supply

- 1 Turn the circuit breaker on.

Result: The flap of the indoor unit will open and close to set the reference position.

5 Operation



INFORMATION

The indoor unit is delivered with the wireless remote control as the user interface. This manual describes only operation with this user interface. If another user interface is connected, refer to the operation manual of the connected user interface.

5.1 Operation range

Use the system in the following temperature and humidity ranges for safe and effective operation.

In combination with outdoor unit RZAG		
	Cooling and drying ^{(a)(b)}	Heating ^(a)
Outdoor temperature	-20~52°C DB	-20~24°C DB -21~18°C WB
Indoor temperature	17~38°C DB 12~28°C WB	10~27°C DB
Indoor humidity	≤80% ^(b)	—

^(a) A safety device might stop the operation of the system if the unit runs outside its operation range.

^(b) Condensation and water dripping might occur if the unit runs outside its operation range.

In combination with outdoor units: 2MXM, 3MXM, 4MXM, 5MXM		
	Cooling and drying ^{(a)(b)}	Heating ^(a)
Outdoor temperature	-10~46°C DB	-15~24°C DB -15~18°C WB
Indoor temperature	18~32°C DB 14~23°C WB	10~30°C DB
Indoor humidity	≤80% ^(b)	—

^(a) A safety device might stop the operation of the system if the unit runs outside its operation range.

^(b) Condensation and water dripping might occur if the unit runs outside its operation range.

In combination with other outdoor units

	Cooling and drying ^{(a)(b)}	Heating ^(a)
Outdoor temperature	-10~50°C DB	-20~24°C DB -21~18°C WB
Indoor temperature	18~32°C DB 14~23°C WB	10~30°C DB
Indoor humidity	≤80% ^(b)	—

^(a) A safety device might stop the operation of the system if the unit runs outside its operation range.

^(b) Condensation and water dripping might occur if the unit runs outside its operation range.

5.2 Operation mode and temperature setpoint

When. Adjust the system operation mode and set the temperature when you want to:





- Heat up or cool down a room
- Blow air in a room without heating or cooling
- Decrease the humidity in a room

What. The system operates differently, depending on the user selection.



INFORMATION

Operation modes: **cooling**, **drying** and **automatic** are NOT available for the **heating only** version of the product.

Setting	Description
 Automatic	The system cools down or heats up a room to the temperature setpoint. It automatically switches between cooling and heating if necessary.
 Drying	The system decreases the humidity in a room.
 Heating	The system heats up a room to the temperature setpoint.
 Cooling	The system cools down a room to the temperature setpoint.
 Fan	The system only controls the airflow (airflow rate and airflow direction). The system does NOT control the temperature.

Additional info:

- **Outside temperature.** The system's cooling or heating effect decreases when the outside temperature is too high or too low.
- **Defrost operation.** During heating operation, frost might occur on the outdoor unit and decrease the heating capacity. In that case, the system automatically switches to defrosting operation to remove the frost. During defrosting operation, hot air is NOT blown from the indoor unit.

5 Operation

5.2.1 To start/stop operation mode and to set the temperature

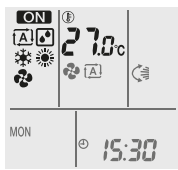

ON: Unit is operating.

A: Operation mode = Automatic

D: Operation mode = Drying

C: Operation mode = Cooling

H: Operation mode = Heating

F: Operation mode = Fan only

88.8: Shows the set temperature.

- 1 Press **Mode** one or more times to select the operation mode.

Result: The mode will be set as follows:



- 2 Press **Power** to **start** operation.

Result: **ON** and the selected mode are displayed on the LCD.

- 3 Press **Temp** or **Temp** one or more times to lower or raise the temperature.

Cooling operation	Heating operation	Automatic operation	Drying or Fan only operation
18~32°C	10~30°C	18~30°C	—

Note: When using **drying** or **fan only** mode, you cannot adjust the temperature.

- 4 Press **Power** to **stop** operation.

Result: **ON** disappears from the LCD. The operation lamp goes off.

5.3 Airflow rate

- 1 Press **Wind** to choose:

	5 airflow rate levels, from "Low" to "High"
A	Automatic airflow rate operation
	Indoor unit quiet operation. When the airflow rate is set to "Quiet", the noise from the unit will be reduced.

i INFORMATION

- If the unit reaches the temperature setpoint in cooling or heating mode, the fan will stop operating.
- When using drying operation mode, you CANNOT adjust the airflow rate setting.

5.3.1 To adjust the airflow rate

- 1 Press **Wind** to change the airflow setting as follows:



5.4 Airflow direction

When. Adjust the airflow direction as desired.

What. The system directs the airflow differently, depending on the user selection (swinging or fixed position). It does so by moving horizontal blades (flaps) or vertical blades (louvers).

Setting	Airflow direction
Vertical automatic swing	Moves up and down.
Horizontal automatic swing	Moves from side to side.
3-D airflow direction	Moves alternately up and down and from side to side
[—]	Stays in a fixed position.

! CAUTION

ALWAYS use the wireless remote control or other user interface (if applicable) to adjust the position of the flaps and louvers. When the flaps and louvers are swinging and you move them forcibly by hand, the mechanism will break.

i INFORMATION

If the Comfort airflow is selected, vertical automatic swing will be canceled.

The movable range of the flap varies according to the operation mode. The flap will stop at the upper position when the airflow rate is changed to low during the up and down swing setting.

5.4.1 To adjust vertical airflow direction

- 1 Press **Vertical**.

Result: appears on the LCD. The flaps (horizontal blades) will begin to swing.

- 2 To use fixed position, press **Vertical** when the flaps reach the desired position.

Result: disappears from the LCD. The flaps will stop moving.

5.4.2 To adjust horizontal airflow direction

- 1 Press **Horizontal**.

Result: appears on the LCD. The louvers (vertical blades) will begin to swing.

- 2 To use fixed position, press **Horizontal** when the louvers reach the desired position.

Result: disappears from the LCD. The louvers will stop moving.

i INFORMATION

When the unit is installed in a corner of a room, the direction of the louvers should be facing away from the wall. Efficiency will drop if a wall blocks the air.

5.4.3 To use 3D airflow direction

- 1 Press **Vertical** and **Horizontal**.

Result: and appear on the LCD. The flaps (horizontal blades) and louvers (vertical blades) will begin to swing.

- 2 To use fixed position, press **Vertical** and **Horizontal** when the flaps and louvers reach the desired position.

Result: and disappear from the LCD. The flaps and the louvers will stop moving.

5.5 Comfort airflow and Intelligent eye operation

You can use Comfort and Intelligent eye operation separately, or combine them.

5.5.1 Comfort airflow operation

This operation can be used in **heating** or **cooling** operation mode. It will provide a comfortable wind that will NOT come in direct contact with people. The system automatically sets the fixed airflow position upward in Cooling and downward in Heating operation mode.

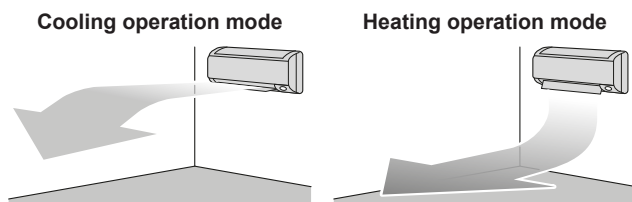

i INFORMATION

Powerful and Comfort airflow operation CANNOT be used at the same time. The last selected function takes priority. If the vertical automatic swing is selected, Comfort airflow operation will be cancelled.

5.5.2 Intelligent eye operation

The system detects movement in the room and automatically adjusts the airflow direction and temperature in order to avoid direct contact with people. If no movement is detected for 20 minutes, the system switches to energy saving operation:

About the Intelligent eye sensor

! NOTICE

- Do NOT hit or push the Intelligent eye sensor. Doing so may lead to malfunction.
- Do NOT place large objects near the Intelligent eye sensor.

i INFORMATION

Night set mode (OFF timer) CANNOT be used at the same time with Intelligent eye operation.



- Detection sensitivity.** Changes according to location, the number of persons in the room, temperature range, etc.
- Detection mistakes.** The sensor may mistakenly detect pets, sunlight, moving curtains, etc.

5.5.3 To start/stop Comfort and Intelligent eye operation

- Press  one or more times.

Result: The setting will change as follows:



Display	Operation
	Comfort airflow
	Intelligent eye
	Comfort airflow and Intelligent eye
—	Both deactivated

Note: If there are people close to the front of the indoor unit or there are too many people, use both operations at the same time.

- To stop operation, press  until both symbols disappear from the LCD.

5.6 Powerful operation

This operation quickly maximizes the cooling/heating effect in any operation mode. You can get the maximum capacity.

i INFORMATION

Powerful operation CANNOT be used together with Econo, Comfort airflow and Outdoor unit quiet operation. The last selected function takes priority.

Powerful operation will NOT increase the capacity of the unit if it already operates at maximum capacity.



5.6.1 To start/stop Powerful operation

- Press  to start.

Result:  is displayed on the LCD. Powerful operation runs for 20 minutes; after that, operation returns to the previously set mode.

- Press  to stop.

Result:  disappears from the LCD.

Note: Powerful operation can be set only when the unit is running. If you press  or if you change operation mode, operation will be cancelled;  disappears from the LCD.

5.7 Econo and Outdoor unit quiet operation

5.7.1 Econo operation

This is a function which enables efficient operation by limiting the maximum power consumption value. This function is useful for cases in which attention should be paid to ensure a circuit breaker will not trip when the product runs alongside other appliances.

i INFORMATION

- Powerful and Econo operation CANNOT be used at the same time. The last selected function takes priority.
- Econo operation reduces power consumption of the outdoor unit by limiting the rotation speed of the compressor. If power consumption is already low, Econo operation will NOT further reduce power consumption.

5.7.2 Outdoor unit quiet operation

Use Outdoor unit quiet operation when you want to decrease the noise level of the outdoor unit. **Example:** At night.

i INFORMATION

- Powerful and Outdoor unit quiet operation CANNOT be used at the same time. The last selected function takes priority.
- This function is only available in Automatic, Cooling, and Heating operation.
- Outdoor unit quiet operation limits the rotation speed of the compressor. If the rotation speed of compressor is already low, Outdoor unit quiet operation will NOT further reduce the compressor rotation speed.



5 Operation

5.7.3 To start/stop Econo and Outdoor unit quiet operation



- 1 Press  one or more times.

Result: The setting will change as follows.



Display	Operation
	Econo
	Outdoor unit quiet
	Econo and Outdoor unit quiet
—	Both deactivated

- 2 To stop operation, press  until both symbols disappear from the LCD.

Note: Econo operation can be only set when the unit is running. Pressing  cancels the setting and  disappears from the LCD.

Note:  remains on the LCD, even if you turn off the unit using the wireless remote control or indoor unit ON/OFF switch.

5.8 Flash Streamer (air cleaning) operation

Streamer generates a high-speed electron stream with a high oxidizing power, reducing bad odours. Together with the titanium apatite deodorising filter, silver allergen removal air purifying filter and the air filters, this function cleans the air in the room.

INFORMATION

- The high-speed electrons are generated and go away inside the unit to ensure safe operation.
- The Streamer discharge may generate a fizzing sound.
- If the airflow becomes weak, the Streamer discharge may stop temporarily to prevent ozone smell.

5.8.1 To start/stop Flash Streamer (air cleaning) operation

Prerequisite: Make sure the unit is operating ( is displayed on the wireless remote control LCD).

- 1 Press .

Result:  is displayed on the LCD and the air in the room is cleaned when the unit is operating.

- 2 To stop operation, press .

Result:  disappears from the LCD and operation stops.

5.9 OFF/ON timer operation

Timer functions are useful for automatically switching the air conditioner off/on at night or in the morning. You can also use OFF timer and ON timer in combination.

There are two types of OFF/ON timer setting:

- **24 hour clock OFF/ON timer** (default). The unit will stop/start operating at the set time. **Example:** The ON timer is set to 13:30, the unit will start operating at 13:30.
- **12 hour countdown OFF/ON timer.** The unit will stop/start operating after the set number of hours. **Example:** The ON timer is set at 10:30 to 3 hours, the unit will start operating at 13:30.

Note: It is possible to combine both timer setting types.

INFORMATION

Program the timer again in case of:

- A breaker has turned the unit off.
- A power failure.
- After replacing batteries in the wireless remote control.



INFORMATION

The clock **MUST** be set correctly before using any timer functions. Refer to "4.3 To set the clock" [p.6].



5.9.1 24 hour clock OFF/ON timer setting

To start/stop OFF timer operation

- 1 Press  to start.



Result:  is displayed on the LCD and **OFF** blinks.  and the day of the week disappear from the LCD.





- 2 Press  or  to change the time setting.
- 3 Press  again.

Result: **OFF** and the set time are displayed on the LCD. The Daikin eye lights orange.

INFORMATION

Each time  or  is pressed, the time setting advances by 10 minutes. Holding the button down will change the setting rapidly.

- 4 To cancel the timer setting, press .

Result: The set time and **OFF** disappear from the LCD.  and the day of the week are displayed on the LCD. The Daikin eye stops lighting orange.

INFORMATION



When you set the ON/OFF timer, the time setting is stored in the memory. The memory will be reset when the wireless remote control batteries are replaced.

Night set mode

When the OFF timer is set, the air conditioner automatically adjusts the temperature setting (0.5°C up in cooling, 2.0°C down in heating) to prevent excessive cooling/heating and ensure a comfortable sleeping temperature.

To start/stop ON timer operation

- 1 Press  to start.

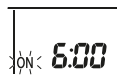

Result:  is displayed on the LCD and **ON** blinks.  and the day of the week disappear from the LCD.





- 2 Press  or  to change the time setting.
- 3 Press  again.

Result: **ON** and the set time are displayed on the LCD. The Daikin eye lights orange.

i INFORMATION

Each time  or  is pressed, the time setting advances by 10 minutes. Holding the button down will change the setting rapidly.

- 4 To cancel the timer setting, press .

Result: The set time and **ON** disappear from the LCD.  and the day of the week are displayed on the LCD. The Daikin eye stops lighting orange.

To combine OFF timer and ON timer

- 1 To set the timers, refer to "To start/stop OFF timer operation" [▶ 10] and "To start/stop ON timer operation" [▶ 10].

Result: **OFF** and **ON** are displayed on the LCD.

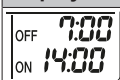

Example:

Display	Current time	Set while...	Operation
	6:00	the unit is operating.	Stops at 7:00 and starts at 14:00.
		the unit is NOT operating.	Starts at 14:00.



Note: If the timer setting is active, the current time is NOT displayed on the LCD.



5.9.2 12 hour countdown OFF/ON timer setting





To start/stop countdown OFF/ON timer operation

- 1 Press and hold  or  for about 5 seconds; when  blinks, release the button.

Result:

 For the OFF timer, *1hr* appears on the LCD and **OFF** blinks,  and the day of the week disappear from the LCD.

 For the ON timer, *1hr* appears on the LCD and **ON** blinks,  and the day of the week disappear from the LCD.

- 2 Press  or  to change the time setting. The time can be set between 1~12 hours. Each pressing of the button increases or decreases the time setting by 1 hour.
- 3 Press  or  to confirm the setting.

Result: **OFF** and/or **ON** and the set time are displayed on the LCD. The Daikin eye lights orange. The time displayed on the LCD will automatically count down by 1 hour for every hour that passes.

Example: If the OFF timer is set to 3 hours, the displayed time will change as follows: 3hr → 2hr → 1hr → blank (OFF)



- 4 To change the setting back to 24 hour OFF/ON timer, repeat step 1 when on the home screen when **OFF** and/or **ON** are NOT blinking.
- 5 To cancel the timer setting, press .

To combine the timer display modes

Different display modes (24 hour and 12 hour countdown OFF/ON timer) can be used for the OFF timer and ON timer simultaneously.

- 1 For setting, see "To start/stop OFF timer operation" [▶ 10], "To start/stop ON timer operation" [▶ 10] and "To start/stop countdown OFF/ON timer operation" [▶ 11].

Example:

Display	Current time	Set while...	Operation
	22:00	the unit is operating.	Stops at 1:00 (3 hours after present time)
			Starts at 6:00. (8 hours after present time)
			

Note: If the timer setting is active, the current time is NOT displayed on the LCD.

5.10 Weekly timer operation

i INFORMATION

The following setting procedure is for the wireless remote control only. However, we recommend to perform the weekly timer setting using the ONECTA app. Refer to "5.11 Wireless LAN connection" [▶ 13] for more information.

With this operation, you can save up to 4 timer settings for each day of the week.

Example: Create a different setting from Monday to Friday and a different setting for weekends.

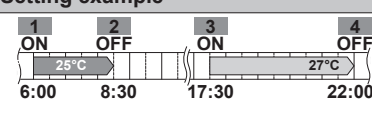
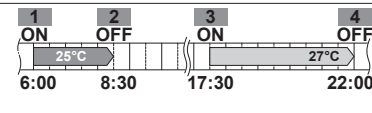
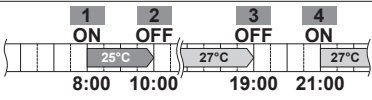
Day of the week	Setting example
Monday	 <ul style="list-style-type: none"> Make up to 4 settings.
Tuesday~Friday	 <ul style="list-style-type: none"> Use the copy mode if the settings are the same as for Monday.
Saturday	<p>—</p> <ul style="list-style-type: none"> No timer setting
Sunday	 <ul style="list-style-type: none"> Make up to 4 settings.

- ON-ON-ON-ON setting.** Enables scheduling the operation mode and set temperature.
- OFF-OFF-OFF-OFF setting.** Only the turn off time can be set for each day.

Note: Be sure to aim the wireless remote control at the indoor unit and check for a receiving tone when setting the Weekly timer operation.

i INFORMATION

The clock **MUST** be set correctly before using any timer functions. Refer to "4.3 To set the clock" [▶ 6].

i INFORMATION

- Weekly timer and OFF/ON timer operation **CANNOT** be used at the same time. The OFF/ON timer operation takes priority. Weekly timer will be in standby,  disappears from the LCD. When the OFF/ON timer is completed, the Weekly timer becomes active.
- The day of the week, OFF/ON timer mode, time and temperature (only for ON timer) can be set with the Weekly timer. Other settings are based on previous ON timer setting.



5 Operation

5.10.1 To set Weekly timer operation

- 1 Press .

Result: The day of the week and the reservation number of the current day are displayed.



- 2 Press  or  to select the day of the week and the reservation number.

- 3 Press .

Result: The day of the week is set.  and ON blink.



- 4 Press  or  to select the mode.

Result: The setting will change as follows:





Display	Feature
ON	ON timer
OFF	OFF timer
Blank	Deletes reservation

- 5 Press .

Result: The OFF/ON timer mode is set.  and the time blink.



Note: Press  to return to the previous screen. If blank is selected, continue to step 9.

- 6 Press  or  to select the time. The time can be set between 0:00~23:50 in 10-minute intervals.

- 7 Press .

Result: The time is set and  and the temperature blink.



Note: Press  to return to the previous screen. If OFF timer is selected, continue to step 9.

- 8 Press  or  to select the desired temperature.

Note: The set temperature for the weekly timer is displayed only when setting the weekly timer mode.



INFORMATION

The temperature can be set between 10~32°C on the wireless remote control, however:

- in cooling and automatic operation mode, the unit will operate at minimum 18°C, even if is set to 10~17°C;
- in heating and automatic operation mode, the unit will operate at maximum 30°C, even if is set to 31~32°C.

- 9 Press .

Result: The temperature and time are set for the ON timer. The time is set for the OFF timer. The Daikin eye lights orange.

Result: A new reservation screen will appear.

- 10 Repeat the previous procedure to set another reservation or press  to complete the setting.



Result:  is displayed on the LCD.

Note: A reservation can be copied with the same settings to another day. Refer to "5.10.2 To copy reservations" [p 12].

5.10.2 To copy reservations

A reservation can be copied to another day. The complete reservation of the selected day of the week will be copied.



- 1 Press .

- 2 Press  or  to select the day of the week to be copied.

- 3 Press .

Result: The reservation of the selected day of the week will be copied.



- 4 Press  or  to select the destination day.

- 5 Press .

Result: The whole reservation is copied to the selected day and the Daikin eye lights orange.

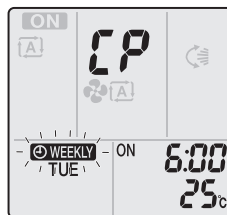

Note: To copy to another day, repeat the procedure.

- 6 Press  to complete the setting.

Result:  is displayed on the LCD.

Note: To change the reservation setting after copying, refer to "5.10.1 To set Weekly timer operation" [p 12].



5.10.3 To confirm reservations

You can confirm if all reservations are set to your needs.

- 1 Press .

Result: The day of the week and the reservation number of the current day are displayed.



- 2 Press  or  to select the day of the week and reservation number to be confirmed and check the reservation details.

Note: To change the reservation setting, refer to "5.10.1 To set Weekly timer operation" [p 12].

- 3 Press  to exit the confirmation mode.

5.10.4 To deactivate and reactivate Weekly timer operation

- 1 To deactivate the Weekly timer, press **Weekly** while **WEEKLY** is displayed on the LCD.

Result: **WEEKLY** disappears from the LCD and the Daikin eye stops lighting orange.

- 2 To reactivate the Weekly timer, press **Weekly** again.

Result: The last set reservation mode will be used.

5.10.5 To delete reservations

To delete individual reservations

Use this function if you want to delete a single reservation setting.

- 1 Press **◀▶**.

Result: The day of the week and the reservation number are displayed.

- 2 Press **Select** or **Select** to select the day of the week to be deleted.

- 3 Press **Next**.

Result: **WEEKLY**, ON, and OFF blink.

- 4 Press **Select** or **Select** and select "blank".

Result: The setting will change as follows:



- 5 Press **Next**.

Result: The selected reservation is deleted.

- 6 Press **◀▶** to exit.

Result: Remaining reservations are active.

To delete a reservation for each day of the week

Use this function if you want to delete all reservation settings for one day of the week. This can be used in confirmation or setting mode.

- 1 Press **◀▶**.

- 2 Press **Select** or **Select** to select the day of the week to be deleted.

- 3 Hold **Weekly** for about 5 seconds.

Result: All reservations for the selected day are deleted.

- 4 Press **◀▶** to exit.

Result: Remaining reservations are active.

To delete all reservations

Use this function if you want to delete all reservations for all days of the week in one go. This procedure CANNOT be used in the setting mode.

- 1 Hold **Weekly** for about 5 seconds while in the default display.

Result: All reservations will be deleted.

5.11 Wireless LAN connection

Simply connect your unit to your home network and download the app to change the thermostat, set temperature schedules, review your energy consumption and more.

For details on specifications, setting methods, FAQ, troubleshooting tips, visit app.daikineurope.com.



The customer is responsible for providing:

- Smartphone or tablet with minimum supported version of Android or iOS, specified on app.daikineurope.com.
- Internet line and communication device, such as a modem, router, etc.
- Wireless LAN access point
- Installed free ONECTA application

Note: If needed, the SSID (Service Set Identifier) and the KEY (password) are located on the unit.

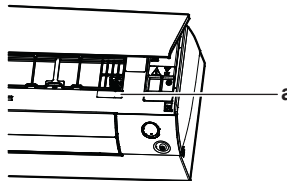

a Label with the SSID and the KEY

5.11.1 Precautions when using the wireless LAN

Do NOT use near:

- **Medical equipment.** E.g. persons using cardiac pacemakers or defibrillators. This product may cause electromagnetic interference.
- **Auto-control equipment.** E.g. automatic doors or fire alarm equipment. This product may cause faulty behaviour of the equipment.
- **Microwave oven.** It may affect wireless LAN communications.

5.11.2 To install the ONECTA app

- 1 Go to Google Play (for Android devices) or the App Store (for iOS devices) and search for "ONECTA".
- 2 Follow the directions on the screen to install the ONECTA app.



INFORMATION

Scan the QR code to download and install the ONECTA app on your mobile phone or tablet:



5.11.3 To set the wireless connection

There are two options to connect the wireless adapter to your home network.

- Using a smart device (smartphone, tablet) and SSID (Service Set Identifier) and KEY (password)
- Using the WPS (Wi-Fi Protected Setup) button on your Wi-Fi router.

For more information and FAQ, refer to app.daikineurope.com.

Note: Setting is done by the wireless remote control in the wireless LAN setting menu. During setting, always aim the wireless remote control at the infrared signal receiver on the unit.

5 Operation

i INFORMATION

Make sure operation is stopped before setting the wireless connection. Connection CANNOT be made when the unit is in operation.

- 1 **Stop operation** before setting the wireless connection.
- 2 Make sure the wireless router is close enough to the unit and nothing obstructs the signal.

Menu	Description
1	Connection status check
2	Connection using WPS button
3	Connection using SSID and KEY
R	Reset to factory default
oFF	Wireless LAN OFF

To confirm the wireless LAN connection status

- 1 On home screen menu, press and hold  for at least 5 seconds while the unit is not operating.

Result: The SP (wireless connection setting menu) appears. 1 is blinking.

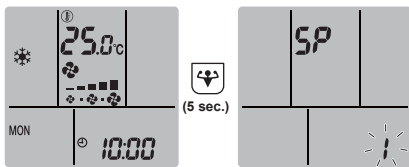

- 2 Press  to confirm the selection.

Result: 1 is blinking.

- 3 Check the Daikin eye.

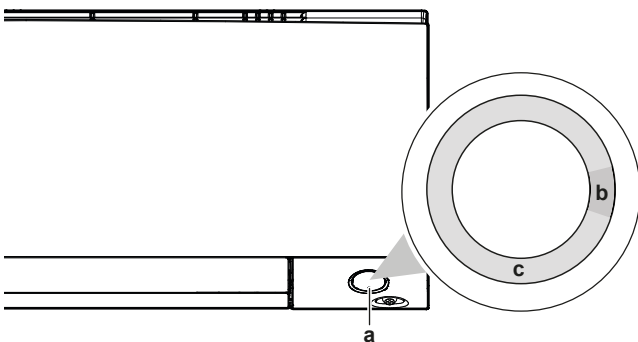

- a Daikin eye
- b Partly green
- c Red, orange or blue

Daikin eye colour alternates between partly green and...	...then wireless adapter is...
Red	not connected
orange	running and ready to connect to the home network via WPS button; see "To connect using the WPS button" [p 14].
blue	connected to the home network: <ul style="list-style-type: none"> ▪ via SSID + KEY. or ▪ via the WPS button on the router.

- 4 Press **Cancel** to exit the menu.

Result: The display will return to the default screen.

To connect the wireless LAN to your home network



The wireless adapter can be connected to your home network using the:

- WPS button (Wi-Fi Protected Setup) on the router (if present),
- The SSID (Service Set Identifier) and the KEY (password) - located on the unit.

To connect using the WPS button

- 1 On home screen menu, hold  for at least 5 seconds while the unit is not operating.

Result: The SP menu 1 appears. 1 is blinking.

- 2 Change to the SP menu 2 by pressing  once or  repeatedly.

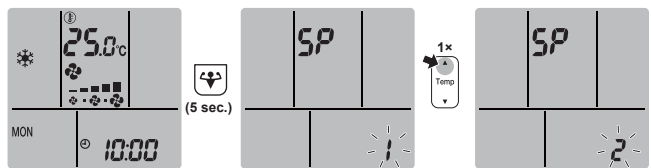

- 3 Press  to confirm the selection.

Result: 2 is blinking. The Daikin eye colour alternates between orange and partly green.

- 4 Press the WPS button on your communication device (e.g. router) within approximately 1 minute. Refer to the manual of your communication device.

Result: The Daikin eye colour alternates between blue and partly green.

i INFORMATION

If the connection with your router is not possible, try procedure "To connect using SSID and KEY number" [p 14].



- 5 Press **Cancel** to exit the menu.

Result: The display will return to the default screen.

To connect using SSID and KEY number

- 1 On home screen menu, hold  for at least 5 seconds while the unit is not operating.

Result: The SP menu 1 appears. 1 is blinking.

- 2 Change to the SP menu 3 by pressing  twice or  repeatedly.

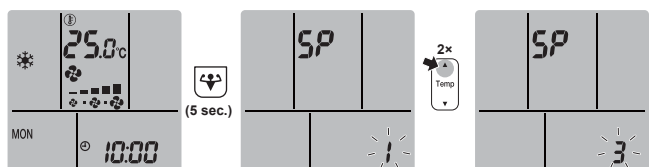

- 3 Press  to confirm the selection.

Result: 3 is blinking. The Daikin eye colour alternates between red and partly green.

- 4 Open the ONECTA application on your smart device and follow the steps on the screen.

Result: If the connection was successful, the Daikin eye colour alternates between blue and partly green.

- 5 Press **Cancel** to exit the menu.

Result: The display will return to the default screen.



To reset the connection setting to the factory default

Reset the connection setting to the factory default in case you want to:

- disconnect the wireless LAN and the communication device (e.g. router) or smart device,
- repeat the setting if the connection was unsuccessful.

- On home screen menu, hold  for at least 5 seconds while the unit is not operating.

Result: The SP menu *i* appears. *i* is blinking.

- Change to the SP menu *R* by pressing  twice or  repeatedly.

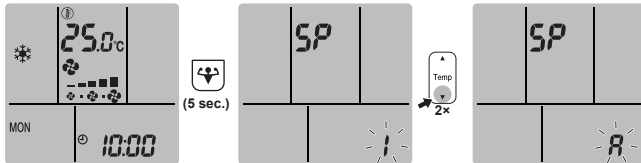

- Hold  for at least 2 seconds to confirm the selection.

Result: *R* is blinking. The Daikin eye colour alternates between red and partly green. The setting is reset to the factory default.

- Press  to exit the menu.



Result: The display will return to the default screen.

To turn off the wireless LAN connection

If you want to turn off the wireless connection function:

- On home screen menu, press  for at least 5 seconds while the unit is not operating.

Result: The SP menu *i* appears. *i* is blinking.

- Change to the SP menu *oFF* by pressing  once or  repeatedly.



- Hold  for at least 2 seconds to confirm the selection.

Result: *oFF* is blinking. The Daikin eye alternates between white and partly green. Communication is OFF.

- Press  to exit the menu.

Result: The display will return to the default screen.

6 Energy saving and optimum operation

INFORMATION

- Even if the unit is turned OFF, it consumes electricity.
- When the power turns back on after a power break, the previously selected mode will be resumed.

CAUTION

NEVER expose little children, plants or animals directly to the airflow.

NOTICE

Do NOT place objects below the indoor and/or outdoor unit that may get wet. Otherwise condensation on the unit or refrigerant pipes, air filter dirt or drain blockage may cause dripping, and objects under the unit may get dirty or damaged.

WARNING

Do NOT place a flammable spray bottle near the air conditioner and do NOT use sprays near the unit. Doing so may result in a fire.

CAUTION

Do NOT operate the system when using a room fumigation-type insecticide. Chemicals could collect in the unit, and endanger the health of people who are hypersensitive to chemicals.

7 Maintenance and service

7.1 Overview: Maintenance and service

The installer has to perform a yearly maintenance.

About the refrigerant

This product contains fluorinated greenhouse gases. Do NOT vent gases into the atmosphere.

Refrigerant type: R32

Global warming potential (GWP) value: 675

NOTICE

Applicable legislation on **fluorinated greenhouse gases** requires that the refrigerant charge of the unit is indicated both in weight and CO₂ equivalent.

Formula to calculate the quantity in CO₂ equivalent tonnes: GWP value of the refrigerant × total refrigerant charge [in kg]/1000

Contact your installer for more information.

NOTICE

Maintenance MUST be done by an authorised installer or service agent.

We recommend performing maintenance at least once a year. However, applicable legislation might require shorter maintenance intervals.

WARNING

- The refrigerant inside the unit is mildly flammable, but normally does NOT leak. If the refrigerant leaks in the room and comes in contact with fire from a burner, a heater, or a cooker, this may result in fire, or the formation of a harmful gas.
- Turn OFF any combustible heating devices, ventilate the room, and contact the dealer where you purchased the unit.
- Do NOT use the unit until a service person confirms that the part from which the refrigerant leaked has been repaired.

7 Maintenance and service

WARNING

- Do NOT pierce or burn refrigerant cycle parts.
- Do NOT use cleaning materials or means to accelerate the defrosting process other than those recommended by the manufacturer.
- Be aware that the refrigerant inside the system is odourless.

WARNING

The appliance shall be stored so as to prevent mechanical damage and in a well-ventilated room without continuously operating ignition sources (e.g. open flames, an operating gas appliance, or an operating electric heater). The room size shall be as specified in the General safety precaution.

DANGER: RISK OF ELECTROCUTION

To clean the air conditioner or air filter, be sure to stop operation and turn all power supplies OFF. Otherwise, an electrical shock and injury may result.

WARNING

To prevent electrical shocks or fire:

- Do NOT rinse the unit.
- Do NOT operate the unit with wet hands.
- Do NOT place any objects containing water on the unit.

CAUTION

After a long use, check the unit stand and fitting for damage. If damaged, the unit may fall and result in injury.

CAUTION

Do NOT touch the heat exchanger fins. These fins are sharp and could result in cutting injuries.

WARNING

Be careful with ladders when working in high places.

Following symbols may occur on the indoor unit:

Symbol	Explanation
	Measure the voltage at the terminals of main circuit capacitors or electrical components before servicing.

7.2 To clean the indoor unit and wireless remote control

WARNING

Improper detergents or cleaning procedure may cause damage on plastic components or water leakage. Splashed detergent on electric components, such as motors, may cause failure, smoke or ignition.

DANGER: RISK OF ELECTROCUTION

Before cleaning, be sure to stop the operation, turn the breaker OFF or pull out the supply cord. Otherwise, an electrical shock and injury may result.

NOTICE

- Do NOT use gasoline, benzene, thinner, polishing powder or liquid insecticide. **Possible consequence:** Discoloration and deformation.
- Do NOT use water or air of 40°C or higher. **Possible consequence:** Discoloration and deformation.
- Do NOT use polishing compounds.
- Do NOT use a scrubbing brush. **Possible consequence:** The surface finishing peels off.
- As an end user, you may NEVER clean inside parts of the unit by yourself; this work must be performed by a qualified service person. Contact your dealer.

- Clean with a soft cloth. If it is difficult to remove stains, use water or a neutral detergent.

7.3 To clean the front panel

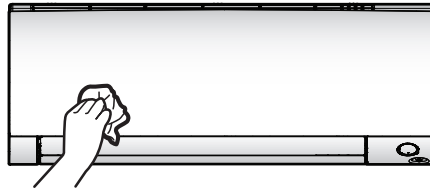

- Clean the front panel with a soft cloth. If it is difficult to remove stains, use water or a neutral detergent.

7.4 To remove the front panel

- Place your fingers in the indentations on the unit (one each on the left and right sides), and open the front panel until it stops.

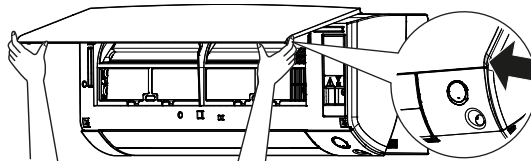

- Push the left panel shaft outward and up to disconnect the front panel from the unit. (Remove the right side front panel shaft in the same manner.)

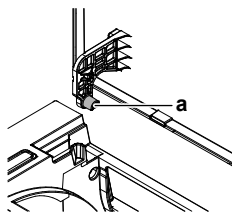

a Front panel shaft

- After removing both front panel shaft, pull the front panel toward yourself and remove it.

7.5 To clean the air filters

- Push the tab at the centre of each air filter, then pull it down.
- Pull out the air filters.

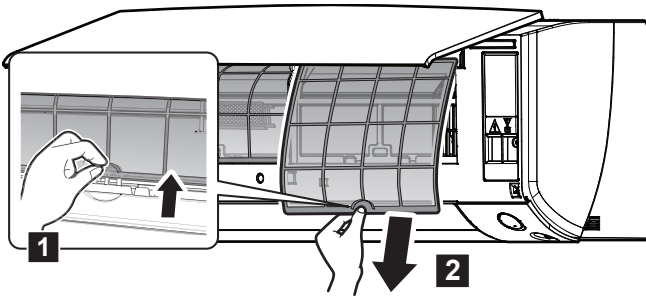

3 Remove the titanium apatite deodorising filter and the silver particle filter from all 4 claws.

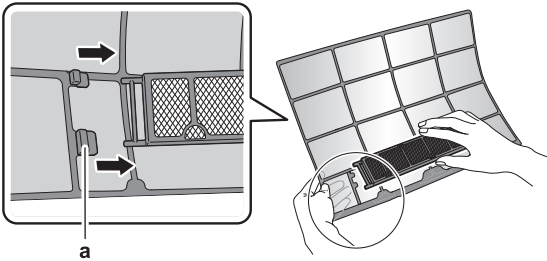

a Claw

4 Wash the air filters with water or clean them with a vacuum cleaner.

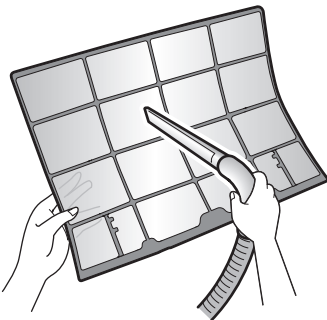

5 Soak in lukewarm water for about 10 to 15 minutes.

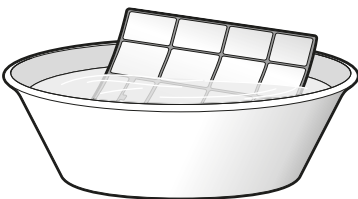

i INFORMATION

- If the dust does NOT come off easily, wash them with a neutral detergent diluted in lukewarm water. Dry the air filters in the shade.
- It is recommended to clean the air filters every 2 weeks.

7.6 To clean the titanium apatite deodorising filter and the silver particle filter (Ag-ion filter)

i INFORMATION

Clean the filter with water every 6 months.

1 Remove the titanium apatite deodorising filter and the silver allergen removal air purifying filter from all 4 claws.

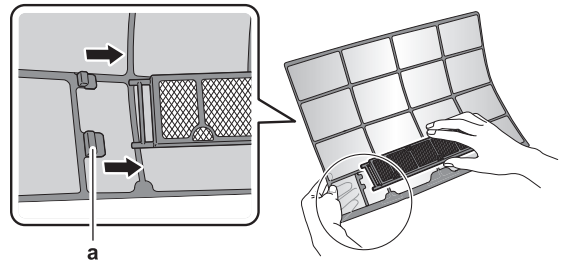

a Tab

2 Remove the dust from the filter with a vacuum cleaner.

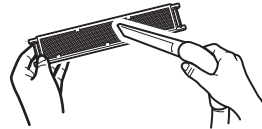

3 Soak the filter for 10 to 15 minutes in warm water.

Note: Do NOT remove the filter from the frame.

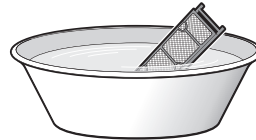

4 After washing, shake off remaining water and dry the filter in the shade. Do NOT wring out the filter when removing water.

7.7 To replace the titanium apatite deodorising filter and the silver particle filter (Ag-ion filter)

i INFORMATION

Replace the filter every 3 years.

1 Remove the filter from the tabs of the filter frame and replace the filter with a new one.

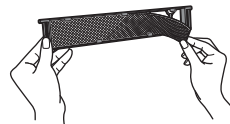

i INFORMATION

- Do NOT throw away the filter frame, but use it again.
- Dispose of the old filter as non-flammable waste.

To order titanium apatite deodorising filter or silver particle filters, contact your dealer.

Item	Part number
Titanium deodorising filter	KAF970A46
Silver particle filter	KAF057A41

7.8 To re-install the front panel

- 1 Attach the front panel. Align the shafts with the slots and push them all the way in.
- 2 Close the front panel slowly; press at both sides and at the centre.

8 Troubleshooting

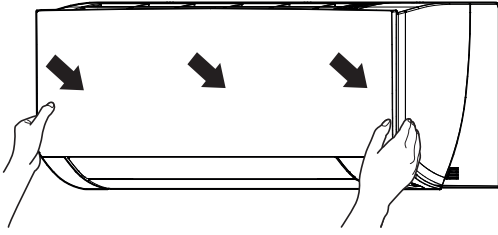

8 Troubleshooting

If one of the following malfunctions occur, take the measures shown below and contact your dealer.



WARNING

Stop operation and shut OFF the power if anything unusual occurs (burning smells etc.).

Leaving the unit running under such circumstances may cause breakage, electrical shock or fire. Contact your dealer.

The system **MUST** be repaired by a qualified service person.

Malfunction	Measure
If a safety device such as a fuse, a breaker or an earth leakage breaker frequently actuates or the ON/OFF switch does NOT properly work.	Turn OFF the main power switch.
If water leaks from the unit.	Stop the operation.
The operation switch does NOT work well.	Turn OFF the power supply.
The Daikin eye flashes and you can check the error code by the wireless remote control. To display the error code see the user reference guide of the indoor unit.	Notify your installer and report the error code.

If the system does NOT operate properly except for the above mentioned cases and none of the above mentioned malfunctions is evident, investigate the system in accordance with the following procedures.



INFORMATION

Refer to the reference guide located on <https://www.daikin.eu> for more troubleshooting tips. Use the search function 🔍 to find your model.

If after checking all above items, it is impossible to fix the problem yourself, contact your installer and state the symptoms, the complete model name of the unit (with manufacturing number if possible) and the installation date (possibly listed on the warranty card).

9 Disposal



NOTICE

Do NOT try to dismantle the system yourself: dismantling of the system, treatment of the refrigerant, oil and other parts **MUST** comply with applicable legislation. Units **MUST** be treated at a specialised treatment facility for reuse, recycling and recovery.

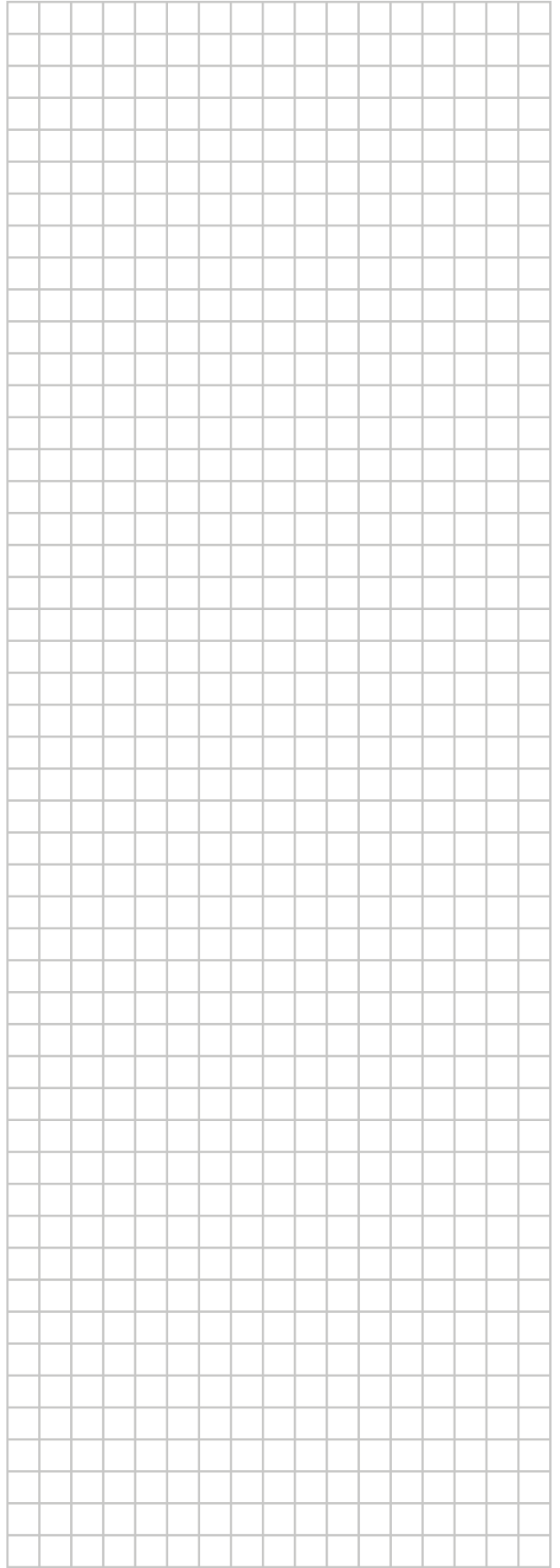

ERC



DAIKIN EUROPE N.V.

Zandvoordestraat 300, B-8400 Oostende, Belgium

DAIKIN INDUSTRIES CZECH REPUBLIC s.r.o.

U Nové Hospody 1/1155, 301 00 Plzeň Skvrňany, Czech Republic

DAIKIN ISITMA VE SOĞUTMA SİSTEMLERİ SAN.TİC. A.Ş.

Gülsuyu Mahallesi, Fevzi Çakmak Caddesi, Burçak Sokak, No:20, 34848 Maltepe

İSTANBUL / TÜRKİYE

Tel: 0216 453 27 00

Faks: 0216 671 06 00

Çağrı Merkezi: 444 999 0

Web: www.daikin.com.tr

Copyright 2023 Daikin

3P728539-3 2023.06